

## Report 04-03-00974 Rev. 0.00

DSB - Expert Assessment of IC4/2

Project-No.: 14.104.00



## EXPERT ASSESSMENT REPORT IC4/2

SBB AG  
Passenger Traffic Operating Sales  
Wylterstrasse 123/125  
Ch-3000 Bern 65  
Switzerland  
Tel. +41 51 220 69 96  
E-Mail: [verkauf.operating@sbb.ch](mailto:verkauf.operating@sbb.ch)

PROSE Ltd.  
Zuercherstrasse 41  
CH-8400 Winterthur  
Switzerland  
Tel: +41 52 262 74 00  
Fax: +41 52 262 74 01  
E-mail: [info@prose.ch](mailto:info@prose.ch)

	<b>name</b>	<b>date</b>	
<b>prepared</b>	C. Bellon, L. Müller, H. Voigt, R. Zimmerli	15.10.2014	
<b>checked</b>	R. Mühlemann	03.12.2014	
<b>released</b>	C. Deiss	03.12.2014	

## Distribution

<b>company / department / name</b>	<b>remarks</b>
DSB / IC4 Program Team / J.B. Johansen / S.S. Christensen SBB / Passenger Traffic Operating / R. Mühlemann PROSE	

This document discloses subject matter in which the PROSE Ltd., Winterthur (Switzerland), has proprietary rights. Neither receipt nor possession thereof confers any right to reproduce or disclose the document, any part thereof, any information contained therein, or any physical article or device, or to practise any methods or process, except by written permission from or written agreement with, PROSE Ltd., Winterthur (Switzerland).

This document is computer-generated and valid without signature.

## Revision Index

	prepared	checked	released	date
04-03-00974	L. Müller	R. Mühlemann	C. Deiss	03.12.2014
Rev.				
Rev.				
Rev.				
Rev.				
Rev.				

## Modifications

revision	description

## Executive Summary

Danske Statsbaner (DSB) has commissioned PROSE Ltd. to undertake an independent external assessment of the current situation of the IC4/IC2 project. The assessment is being undertaken by PROSE with consultant support from Swiss Federal Railways.

DSB has 82 IC4 4-coaches and 23 IC2 2-coaches diesel trainsets. These trainsets proved not to be suitable for operation. DSB found itself in the unique situation where a train operator is taking over the responsibility of completing newly built trainsets, instead of the manufacturer.

This assessment is focussed on the IC4 trainsets. The objective is to assess if it is worthwhile for DSB to continue spending resources on the train types IC4 and IC2 and if so, to what extent. It should be assessed in detail if the goals defined in the deployment plan by DSB regarding availability, reliability and functionality are realistic and if they can be met by the measures taken by DSB, and if not, what measures should be additionally defined.

By end of October 2014 the IC4 fleet performed a total mileage of 10.8 Mio km, 30% this year. Currently the trainsets are limited to operate in single traction and the maximum speed is reduced.

Due to the individual trainset configuration status, error finding and root cause analysis is more difficult and time consuming. Due to the poor reliability of the trainset and additional inspections, the maintenance efficiency is low which leads to high operational costs.

The final availability goal to have 74 IC4 trainsets in operation in 2019 is realistic since DSB has the required maintenance infrastructure as well as procedures in place to support this availability deployment. The current availability requirement to have 32 trainsets ready for operation twice a day is achieved.

The final reliability goal of 20,000 km mean distance between failures is in the long term realistic compared to other vehicles and operators. Currently reliability is not given priority over availability and functionality. The reliability goal is not achievable, and furthermore the improvement potential addressed is not even enough to address the today's goal.

The final functionality goals assessed are realistic from a technical point of view. The intermediate phase (fixed couplings and 180 km/h) is delayed. All other goals are still achievable.

Measures defined by DSB are pointing in the right direction. However, additional measures are required to achieve the goals set out in the deployment plan. The engineering capacity should be increased by at least 12 Full-time Equivalent (FTE) to improve failure analysis, set up the task force for the power pack and defining measures and an increase in the workshop staff by at least 40 FTE is required. This is to speed up the "Rebuild and Campaigns to the IC4 and IC2 fleet" (CFG) implementation.

Five designated IC4 trainsets shall be prioritised for use to collect mileages so that an indication can be obtained as to how the rest of the fleet will perform at a later stage.

The defined processes of IC4 program team shall be followed consequently and conscientiously. In general the organisation and quality management system are sufficient to reach the goals.

The goal to operate in fixed double traction is dependent upon the software approval of the "Train Computer and Monitoring System". The defined modifications have to be properly validated.

The root cause analysis for fractures in the damper support of the axle box housing has to be completed.

The brake system has to be properly analysed and a validation plan for the new blending parameters needs to be set up.

Due to the high number of failures identified in the power pack and the complexity of the system, the power pack has to be analysed by the task force. The current solution on the power pack and the axle box housing is indicating weaknesses and this could lead to major design changes.

The balance with recommended measures in 2019 is 111.2 Mio DKK, 1.5 Mio DKK per trainset (74 trainsets). Taking into account the risks for a design change the balance can vary from 0.7 Mio DKK to -0.7 Mio DKK per trainset. This balance is based on the scope considered within this assessment. Therefore additional costs may occur.

Due to the delay in the procurement of the trainsets and therefore the shorter usable life cycle of the fleet, the investment made is poor. In the current situation the trains cannot be operated as expected but the investment to reach the deployment plan is known based on defined and recommended measures by this assessment. This allows a comparison with alternative solutions. Hence DSB advised development of the trainsets according to the deployment plan in order to allow an operation of the fleets on their natural lifecycle. Regardless of the amount of trainsets used and their duration of operation, the trainsets only have a value if the functionality and the reliability goals are reached. It is recommended that the IC4 trainsets are operated mainly in long distance traffic.

Today is a completely different situation compared to October 2011, where the Atkins report was elaborated. Atkins concluded that the fundamental systems and major items of equipment fitted to IC4 trainsets are sound and are currently operating reliably. Unfortunately now this is not the case as identified during the technical risk assessment.

The assessment has been carried out within a limited timeframe but with the aim to cover all necessary topics related to the IC4 program. This means that the assessment is based on the interviews performed and the documentation provided and is of a limited scope.

This technical assessment does cover all currently addressed issues, but future issues could occur. Due to reasonable suspicion other systems also fitted to trainsets might be incompletely engineered.

## Content

<b>1</b>	<b>Introduction</b>	<b>7</b>
<b>2</b>	<b>Goals set by DSB for the IC4 fleet</b>	<b>10</b>
<b>3</b>	<b>Assessment Results</b>	<b>11</b>
<b>4</b>	<b>Current status of the IC4 fleet</b>	<b>17</b>
<b>5</b>	<b>Financial appraisal IC4 trainsets</b>	<b>20</b>
<b>6</b>	<b>Appraisal “Organisation”</b>	<b>23</b>
<b>7</b>	<b>Appraisal “Quality management”</b>	<b>26</b>
<b>8</b>	<b>Appraisal “Workshop Performance”</b>	<b>31</b>
<b>9</b>	<b>Appraisal “MDBF Improvement and goals”</b>	<b>37</b>
<b>10</b>	<b>Appraisal “Technical risk assessment of main functions”</b>	<b>39</b>
<b>11</b>	<b>Differences in conclusion to the Atkins report</b>	<b>82</b>
<b>12</b>	<b>Abbreviations, Terminology</b>	<b>83</b>
<b>13</b>	<b>Appendices</b>	<b>84</b>

# 1 Introduction

DSB has commissioned PROSE Ltd. to undertake an independent external assessment of the current situation of the IC4/IC2 project in terms of whether it is worthwhile for DSB to continue spending resources on the train types IC4 and IC2. The assessment is being undertaken by PROSE with consultant support from Swiss Federal Railways (SBB).

## 1.1 Task Definition

The assessment shall give answers to the following questions:

- Are the goals defined by DSB regarding availability and reliability realistic and can they be met by the measures taken by DSB, and if not, what measures should be additionally defined?
- Are the goals of DSB concerning performance and trainset availability in 2019 realistic? If not, what is a realistic goal relative to economy and technique? Are the measures defined by DSB already enough? If not, what are the consequences of additional measures seen from a technical, economical, operational and safety point of view?
- Is the deployment plan and performance plan of the IC4 economically viable relative to the fact that the Danish lines are going to be electrified? Is the service life of the IC4/IC2 economically affected by the purchase of new trains?

## 1.2 Assignment

The assignment has been carried out by PROSE in close cooperation with SBB and support of ENOTRAC. The assessment has been carried out between 26 August and 4 December 2014. Onsite visits were performed at DSB headquarters in Høje Tåstrup, as well as the workshops Sonnesgade and Augustenborggade in Århus and Kastrup Airport Copenhagen (KAC). During the visits various inspections, meetings and interviews were carried out. Besides the DSB maintenance internal partners Trafikstyrelsen, DSB operation, DSB economics and DSB safety were also interviewed.

## 1.3 Approach

Due to its complexity the assessment was divided into two phases.

The first phase focused on the collection of information in order to become acquainted with the design of the trainset and the organisation itself, the defined measures and the issues of the systems. This phase was performed in three weeks between 26 August and 12 September 2014. The goal was to define and prioritise the focus areas to be assessed in the second phase.

The second phase focused firstly on the focus areas defined by the assessment team, which were: organisation, quality management, workshop performance, Mean Distance Between Failure causing a delay > 5min (MDBF) improvement and goals, technical risk assessment of main functions.

The starting point of the technical risk assessment is the list of the main functions that have to be improved as well as the required CFGs and modifications to be in place in order to achieve the following identified main technical functions:

- Coupling multiple traction: These modifications should relieve the limitation of single traction operation
- Brake (Blending, Wheels Slide Protection, ...): These modifications should relieve the current speed reductions
- Axle box housing: Cracks were detected in the lower wheel-set-bearing-housing.
- Power pack: Several integration problems and defects of components in the power pack (PP) reduce the availability of the trainset.

The focus has been placed on the critical CFGs that are about to be implemented and on the main functions of the trainsets.

Secondly, to develop a comprehensive overview of the findings of the focus areas and the financial assessment in order to answer the questions raised in the task definition.

## 1.4 Report Structure

There is a two-page stand-alone executive summary in the front.

The chapter 1 introduction provides all administrative information, such as the task definition, the approach and the structure of the report. This provides the reader with the correct foundation.

Chapter 2 provides the goals set by DSB and explains them in detail.

Chapter 3 provides an overview of the assessment results summarised. The answers given are referred directly to the questions stated in the task definition. The analyses including the considered documentation are detailed in the corresponding chapters.

Chapter 4 gives information on the current state of the IC4 fleet. This is a fact-based capture of the current situation.

Chapter 5 provides the financial appraisal including capital expenditures (CAPEX) and operational expenditure (OPEX).

The following chapters provide information on a focus area chosen by the expert assessment team:

- Chapter 6 Organisation
- Chapter 7 Quality management
- Chapter 8 Workshop performance
- Chapter 9 MDBF improvement and goals
- Chapter 10 Technical risk assessment of main functions

Chapter 11 highlights the differences in conclusion with the Atkins report.

Chapter 12 lists all abbreviations used.

Chapter 13 Appendices provides a list of annexes.

Please note journal references: meetings, interview and visits are given as follows (A1, 01). References to the document reference list are given as follows (A2, 001).



## 1.5 Schedule

Based on the tight time schedule, a tight and meticulous interview plan was implemented. All interviews, meetings and various inspection tours have been coordinated by DSB in a professional manner.

## 2 Goals set by DSB for the IC4 fleet

The IC4-Program of DSB is working on three goals simultaneously. These goals are relevant for the assessment (As per task definition in the introduction chapter 1).

- **Increase the availability of the rolling stock.** In 2019 74 IC4 trainsets should be in operation.
- **Increase in reliability.** In 2019 the reliability of the IC4 trainsets should reach at least a MDBF value of 20,000 km.
- **Increase the functionality of the rolling stock.** In 2019 all functionalities should be available. Today's restrictions are speed limitation to 169 km/h and additionally to 140 km/h during fall time. Furthermore the operation is limited to single traction.

The three goals are visualised in the figure 2-1.

The prerequisites define the requirements to be met in the respective phases.

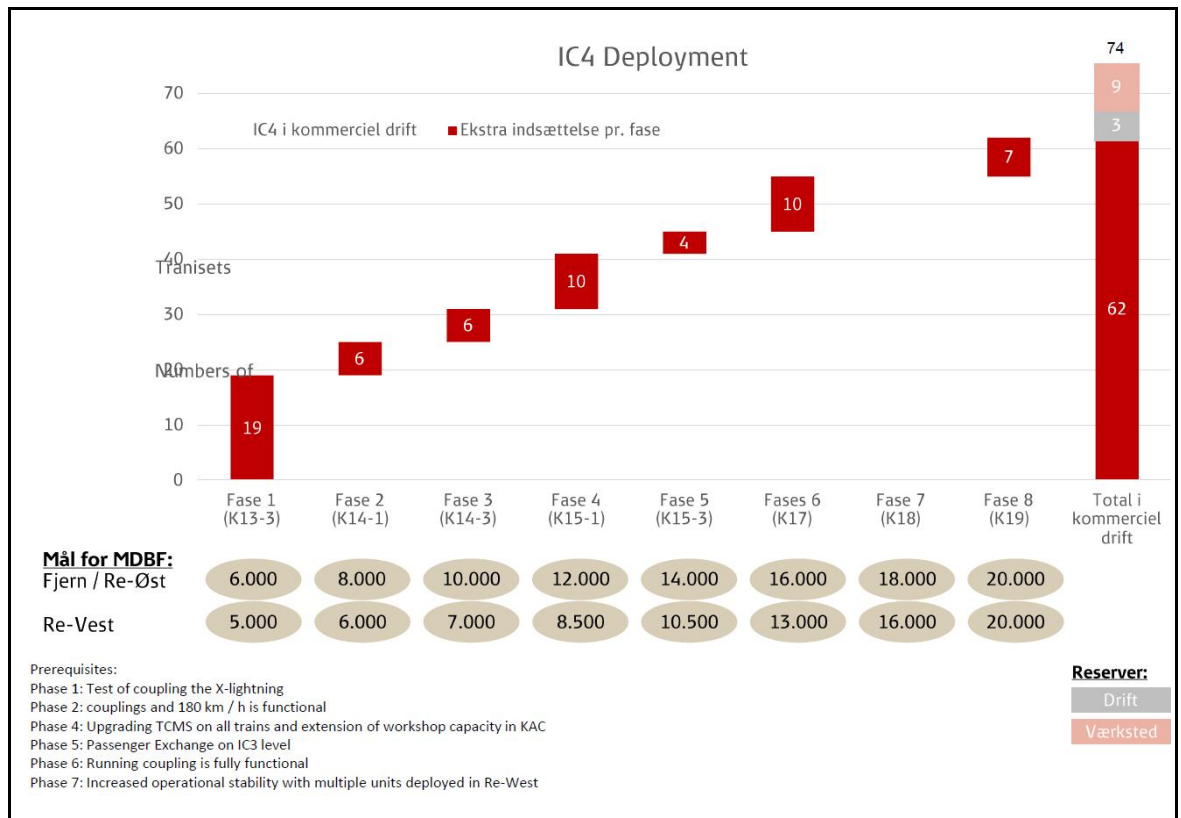

figure 2-1: DSB Deployment plan for IC4 trainsets (A2, 015)

### 3 Assessment Results

This chapter summarised the result of the assessment. All details including the references to the documentation assessed are given in the corresponding appraisal chapters.

#### 3.1 Current status IC4 trainsets

The current availability requirement is to have 32 trainsets ready for operation twice a day. The total mileage of the fleet by end of October 2014 is 10.8 Mio km. In the period from the 1 January until 31 October 2014 the mileage of the fleet is 3.07 Mio km.

The MDBF baseline calculated as average is 5,949 km between January and August 2014. Currently the trainsets are only operated in single operation (not in multiple operations as coupled units), and the maximum speed is limited.

On a large number of trainsets a high amount of CFGs are already implemented. However, each trainset has its individual current status of CFGs implemented. Due to the poor reliability of the trainset and additional inspections, the maintenance efficiency is low. This leads to high operational costs.

#### 3.2 Deployment plan IC4 trainsets

The provided deployment plan as per figure 2-1 contains three dimensions: Availability, Reliability and Functionality.

Following assessment results could be stated:

- **Availability**

The final goal regarding availability is realistic. This requires keeping a clear focus on “Availability” in the workshop, as well as the required man-power. As a prerequisite for the future increase of availability, a positive development in trainset reliability is required. DSB has the required maintenance infrastructure as well as procedures in place to support this availability deployment.

- **Reliability**

The final goal of 20,000 km MDBF regarding reliability is realistic in the long term in comparison with other vehicles and operators. Currently reliability is not given the same priority as availability and functionality. The MDBF baseline as an average of the fleet (January till August 2014) is 5,949 km for operation in regional and long distance traffic. The goal as per the deployment plan should be 7,260 km in January 2014 and increase to 9,077 km in August 2014. The total reliability improvement potential addressed is 2,473 km. This is not even sufficient to reach the goal defined for August 2014. However the MDBF of 13,687 km (A2, 406) only for November 2014 shows a positive tendency.

- **Functionalities**

The final goals of the functionalities assessed are realistic from a technical point of view. Phase 2 (fixed couplings and 180 km/h) is delayed. Please note the completion of phase 2 will increase the operability of the trainset. All other goals are still achievable.

### 3.3 Additional measures recommended and their consequences

DSB set up a deployment plan to define the goals. Measures have already been defined by DSB in the areas of organisation, operation, processes and for the improvement of technical solutions. The assessed measures are pointing in the right direction. However, additional measures in these areas are recommended. The recommended measures are addressed by the consequences from a technical, economical, operational and safety point of view.

#### 3.3.1 Deployment plan

- Measures recommended
  - Plan to be maintained by owner
  - Goals must be monitored and communicated because they are partly unknown as determined during interviews with DSB Operation and in workshop KAC
  
- Consequences
  - None identified

#### 3.3.2 Organisation

- Measures recommended
  - Set up a task force team on the power pack
  - Improve the reporting of failure messages by cross-functional teams including drivers, engineering (hardware, software) and workshop staff; additionally these teams shall be used to reproduce errors in close collaboration
  - Increase in experienced Reliability Improvement Team (RIT) and Engineering capacity by at least 10 FTE (this includes the task force and cross functional teams) to improve failure analysis and defining measures
  - Increase of experienced Train Computer and Monitoring System (TCMS) Engineering capacity by at least 2 FTE
  - Increase of the workshop staff by at least 40 FTE to speed up the CFG implementation
  - Establish resource management for unexpected critical technical issues
  
- Consequences
  - Additional RIT and Engineering staff (This includes TCMS transfer team) of 12 FTE for next 3 years is required which amounts to approx. 43.2 Mio DKK
  - To speed up the CFG implementation additional maintenance staff of 40 FTE for next 2 years is required which amounts to approx. 37.1 Mio DKK
  - Only consequences in the area of economics have been identified.

### 3.3.3 Operation

- Measures recommended
  - Five IC4 trainsets shall be designated to collect mileages. Therefore these trainsets shall be prioritised for use in long distance traffic. The aim is to collect mileages within a short time period in order to obtain an indication of how the rest of the fleet will perform at a later stage.
- Consequences
  - None identified

### 3.3.4 Process

- Measures recommended
  - Follow the defined processes of IC4PT consequently and conscientiously, especially:
    - Root cause analysis (RCA)
    - Definition of requirements (qualitative instead of quantitative)
    - Verification, validation and testing
  - Implementation of the activity “compiling FMEA and validation plan” when a CFG is started
- Consequences
  - None identified

### 3.3.5 Improvement of technical solutions

- Measures recommended
  - Coupling multiple traction
    - The TCMS software version required for operation in fixed coupled double traction is not yet approved by the TS. Therefore the approval shall have the greatest focus within the IC4PT.
  - Axle box housing
    - Completion of the RCA
  - Brake system
    - Define a validation plan for the new blending parameters
    - Analyse the side effects of each modification, i.e. influence of the new BCU-software version 1.16 on the performance of the Wheels Slide Protection System (WSP)
    - Deepen the knowledge of the system and the components with the goal to identify the potential for increased system reliability
  - Power pack (PP)
    - RCA of current breakdowns of the crankshaft bearings in the engine in order to identify the root cause of the damaged bearings, which may concern the entire fleet or not, and to define specific corrective actions.

- Expand on design knowledge and repeat necessary validation (type) tests with the goal of assessing the risk of a design failure
- Consequences
  - About < 1 Mio DKK for PP and axle box related non-recurring cost measures (From economical point of view)
- Possible consequences
  - The current solutions on the power pack and the axle box housing are indicating weaknesses and these could lead to major design changes:
    - Design change leads to new engine, costings about 2 Mio DKK per trainset
    - Design change leads to engine retrofit activities, costings about 800,000 DKK per trainset
    - Design change leads to new axle box housings, costings about 200,000 DKK per trainset

### 3.3.6 Financial overview

The balance as at today is based on the original project frame credit. Taking the above additional economic consequences into account, the following balance is given (74 trainsets considered):

- Balance as at today (Coupler refurbishment considered): 437 Mio DKK
- Balance with planned measures by DSB in 2019: 192.5 Mio DKK
- Balance with recommended measures in 2019: 111.2 Mio DKK

That means per trainset the remaining budget is 1.5 Mio DKK in 2019 with all recommendations considered.

Taking into account the risks of a design change the following balance is given:

- Balance 2019 incl. PP bearing retrofit activities: 52.0 Mio DKK
  - per trainset: 0.7 Mio DKK
- Balance 2019 incl. PP bearing & new axle box retrofit activities: 37.2 Mio DKK
  - per trainset: 0.5 Mio DKK
- Balance 2019 incl. PP new motor & new axle box retrofit activities: -51.6 Mio DKK
  - per trainset: -0.7 Mio DKK

This balance is based on the scope considered within this assessment. Therefore additional costs may occur.

### 3.4 Life time IC4/IC2 trainsets

Due to the delay in the procurement of the trainsets and therefore the shorter usable life cycle of the fleet, the investment made is poor. In the current situation the trains cannot be operated as expected but the investment to reach the deployment plan is known based on defined and recommended measures by this assessment. Hence DSB advised the development of the trainsets according to the deployment plan in order to allow an operation of the fleets on their natural lifecycle as long as the LCC performance is better than available alternatives.

Regardless of the amount of trainsets used and their duration of operation, the trainsets only have a value if the functionality and the reliability goals are reached.

### 3.5 Operational pattern

During the assessment DSB asked for a recommendation about the future usage of the IC4 trainsets regarding interregional / regional.

It is recommended that the IC4 trainsets are operated mainly in interregional traffic as specified (long distance train). This recommendation is based on the following facts:

- The IC4 trainset is a very heavy train with a 3.3 ton higher maximum axle load - 21.24 tons compared to available alternative DMU IC3
- Regional operation means shorter distance between stops and greater number of stops compared to interregional traffic, leading to
  - Higher passenger exchange rates required
  - Higher demands, especially for propulsion system, brake system and door system
  - Higher wear on parts such as brake pads and wheels, resulting in additional maintenance
  - Higher fuel consumption
- Lower MDBF figures

### 3.6 Differences compared to Atkins report

Today is a completely different situation compared to October 2011, where the Atkins report was elaborated. The last trainsets were completed by the end of year 2013. Now the trainsets are in operation collecting more mileages and operational experience.

Due to several reasons such as poor workmanship, bad design and incomplete engineering, failures, especially of a dynamic nature resulting from service, still occur after a certain period of time. Due to this reason, differences relative to the conclusions of the Atkins report in 2011 were identified throughout our assessment in a number of specific topics.

Atkins concludes that the fundamental systems and major items of equipment fitted to IC4 trainsets are sound and are currently operating reliably. Unfortunately now this is not the case as identified during the technical risk assessment.



## 4 Current status of the IC4 fleet

### 4.1 IC4 fleet configuration

The fleet consists of 82 trainsets, containing:

- 67 trainsets approved for operation (A1, 04)
- 5 trainsets are taken apart for spare parts, cannibalising (A1, 04)
- 74 trainsets shows the deployment plan for 2019 (A2, 015)

The availability requirement is reached by 32 trainsets ready for operation twice a day. 12 of the 32 trainsets are in passenger operation service, the others are serviced as operational reserve.

### 4.2 IC4 trainset configuration relating to CFG implementation

The following observation has been made by assessing the trainset configurations (A02, 091). It contains the implementation status of all modifications and CFG which has been implemented. It reflects the following status by the 30 September 2014:

- The trainset 5655 has with 103 CFG the highest number of CFGs implemented
- CFGs have been implemented on 58 different IC4 trainsets in August and September 2014
- The fleet can be categorised into three groups:
  - On 5 trainsets (5606, 5607, 5612, 5613 and 5614) only 7 CFGs are implemented. On all these trainsets, at least one CFG has been implemented in September 2014.
  - On 6 trainsets, between 46 and 67 CFGs are implemented. Between May and August, on all trainsets at least one CFG has been implemented.
  - On 71 trainsets, between 75 and 103 CFGs are implemented. Since April on all trainsets at least one CFG has been implemented.

### 4.3 IC4 trainset mileages

The total mileage of the fleet of 82 trainsets by end of October 2014 is 10.8 Mio km (A2, 030). Four trainsets still have 0 km (trainset no. 86-5678, -79, -80, -83).

The following observations have been made by assessing the trainset mileages (A2, 030/374) for the mileages performed during the period from the 1 January until 31 October 2014, see figure 4-1:

- 80% of the fleet mileages were performed by 31 different trainsets
- 50% of the fleet mileages were performed by 17 different trainsets
- <1% of the fleet mileages were performed by 30 different trainsets
- The entire fleet performed 3.07 Mio km in total

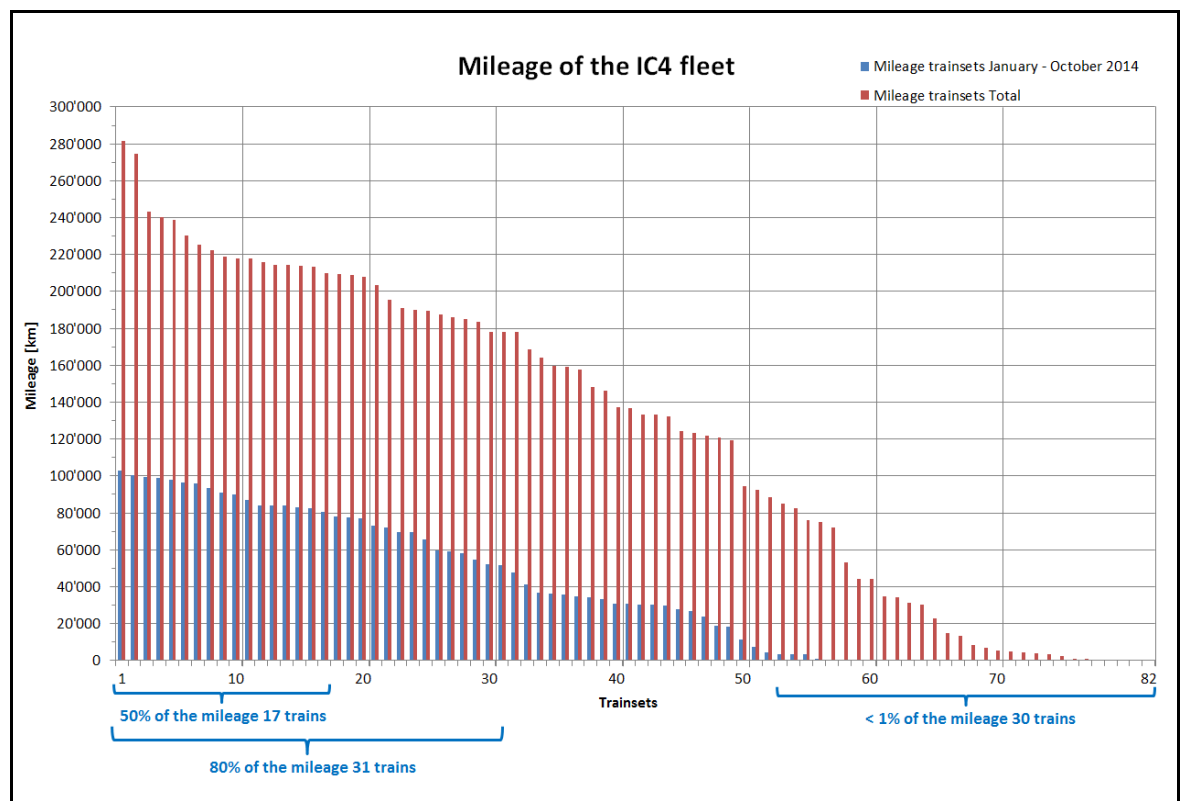

figure 4-1: Mileage of the fleet, total and in period from the 1 January until 31 October 2014 (A2, 030/374)

The expected future mileage level per trainset/year has been adjusted to 190,000 km (A02, 339). In the original tender specification an annual mileage of 350,000 km has been specified per IC4 trainset (A02, 348).

#### **4.4 IC4 trainset TCMS software status**

On the 7 November 2014, the implementation of the TC and GTW version 2.1 and the IDU software version 2.2a was introduced on the fleet. The IDU version 2.2a is a further development of the IDU version 2.1. The homologation of the version 2.1 is limited to single train operation (A2, 349). The version 2.2a has been classified by DSB as not significant, which has been confirmed by the National Safety Authority Trafikstyrelsen (TS). Therefore no dedicated homologation for the IDU version 2.2a is required.

The TC, the GTW and IDU all have their own software. All three systems are collectively named TCMS (A2, 354).

## 5 Financial appraisal IC4 trainsets

### 5.1 Package Summary

The allocated CAPEX will be sufficient to bring the majority of trainsets up to the specified level defined by the deployment plan with the measures defined by DSB and additionally recommended measures. However, there is a risk of exceeding this in the event that a new engine is required for the power pack or additional, non-assessed system parts requiring substantial modification.

Due to late commission of the IC4 fleet the full usage period has been shortened from 25 to approx. 15 years.

The current operational costs are reflecting the currently poor reliability of the IC4 fleet as well as the suboptimal inefficient maintenance. This will change when the MDBF improves.

### 5.2 Capital Expenditure / CAPEX

This chapter compares the expected cost to achieve the goals set by DSB with the original project outline cost.

#### 5.2.1 Current Situation

As per the provided financial overview (A02, 399) there is a balance of 475 Mio DKK, hence 6.4 Mio DKK per IC4 trainset equivalent to 74 trainsets left from the original project frame to complete the trainsets to specification level. 38 Mio DKK is allocated for the mechanical refurbishment of the coupler.

#### 5.2.2 Cost Estimate to complete the trains

##### 5.2.2.1 Measures already defined by DSB

The following costs are estimated based on the assessment to fulfil the goals of the deployment plan:

- IC4PT Management, Engineering and RIT with actual 30 FTE as per the current burn rate (A02, 339) for 2015 - 2019 (assumption) is estimated at a total of 180 Mio DKK
- Burn rate workshop with 40 FTE (assumption) as at the current hourly rate of 306 DKK (A02, 400) and 1515 h p.a. for 2015 – 2017 (assumption) is estimated at a total of 55.6 Mio DKK
- Material costs for smaller modifications estimated at 120,000 DKK (assumption) per IC4 trainset (8.88 Mio DKK for 74 trainsets)

The balance by 2019 with defined measures by DSB will be following:

- Balance as at today: 475 Mio DKK
- Cost for coupler modification: 38 DKK
- Burn rate IC4PT Management, Engineering and RIT: 180 Mio DKK
- Burn rate workshop: 55.6 Mio DKK
- Material costs: 8.88.Mio DKK
- Balance in 2019 with defined and planned measures by DSB: 192.5 Mio. DKK

### 5.2.2.2 Additional measures recommended

Based on the additional measures as recommended in chapters 7.2.3, 9.2 and 10.2 the following costs are estimated:

- Burn rate with 12 FTE of additional staff for IC4PT Engineering and RIT as per the current burn rate (A02, 339) for 2015 - 2017 is estimated at a total of 43.2 Mio DKK
- Burn rate with 40 FTE for additional workshop staff to implement CFGs as per the current hourly rate of 306 DKK and 1,515 h p.a. (A02, 400) for 2015 – 2016 is estimated at a total of 37.1 Mio DKK
- PP and axle box -> non-recurring cost measurement such as completing external RCA as well as function & type tests on test-bench estimate data total of < 1 Mio DKK
- Sum of additional recommended measures: 81.3 Mio DKK

The balance by 2019 with additional measures as recommended:

- Balance in 2019 with defined and planned measures by DSB: 192.5 Mio DKK
- Sum of additional recommended measures: 81.3 Mio DKK
- Balance in 2019 with additional proposed measures: 111.2 Mio DKK
- Balance per trainset (74 trainsets): 1.5 Mio DKK

Taking into account the risks of a design change, the following balance is given (See chapter 10.2.5):

- |   |               |
|---|---------------|
| • Balance 2019 incl. PP bearing retrofit activities:                  | 52.0 Mio DKK  |
| per trainset:   | 0.7 Mio DKK   |
| • Balance 2019 incl. PP bearing & new axle box retrofit activities:   | 37.2 Mio DKK  |
| per trainset:   | 0.5 Mio DKK   |
| • Balance 2019 incl. PP new motor & new axle box retrofit activities: | -51.6 Mio DKK |
| per trainset:   | -0.7 Mio DKK  |

To reduce or eliminate the costs mentioned above the recommended power pack task force should be setup as soon as possible.

### **5.2.3 Usage period**

As per the provided figures the original usage period was planned to 25 years (A2, 339/370). Due to late commission of the IC4 fleet the full usage period has been shortened from 25 years (2005 – 2030) to approx. 15 years (2015 – 2030) with the entire fleet performing the yearly mileages.

## **5.3 Operational Expenditure / OPEX**

This chapter compares the operation cost generated from the workshop activities with other fleets.

As per the provided financial overview (A02, 339) the operational cost representing the maintenance efforts is in line with the hours spent (A02, 194). Due to the high level of unscheduled corrective maintenance (UCM) and the low amount of mileages driven, the operational cost for the IC4 fleet is compared to the other DSB fleet types very high. In the actual phase of the IC4PT programme these figures are not comparable. This means DSB needs to find a fast way to bring IC4 fleet out of this phase.

## 6 Appraisal “Organisation”

### 6.1 Summary

In terms of the organisation the assessment reveals

- Well-functioning organisation and processes
- Improved collaboration required between IC4PT and DSB-S to enhance proper risk evaluation
- Additional man power resources should be provided
- Fault-prone, complex systems should be handled externally by special task forces

### 6.2 Assessment and Findings

#### 6.2.1 Present Status

A huge change in the organisation was introduced at the beginning of this year 2014. That means IC4 Program Team (IC4PT ) is no longer a standalone organisation alongside to DSB Maintenance (DSB-M), but now integrated as an organisation in the DSB-M. DSB-M is highly focused on the handling of IC4 and IC2 trainsets like other trainsets in a normal maintenance organisation. Part of this reorganisation and therefore valid for the IC4PT is the independent DSB safety department (DSB-S) which ensures risk evaluation of every change.

Due to the high level of additional effort, especially with regard to fleet modifications by CFG an IC4PT organisation still exists including associated Quality Management System (QMS). It is important for the IC4PT to have its own QMS due to the complexity and quantity of the modifications. It requests not only a lot of human resources but also handling and agreement in regard to standards up to date respectively state of the art and applicable rules for “Authorisation for placing in service” or “Authorisation of types of trainset” with TS.

The independent DSB-S is carries out risk evaluations for each change relying upon comprehensive and proper information coming from IC4PT Engineering. Currently there is a resource-consuming bottleneck because for each CFG, precisely minor changes, the IC4PT Engineering has to prepare comprehensive documentation acc. to their process P10.10 (A2, 108). Based on that DSB-S is able to carry out risk evaluations and has to forward it to TS. On one hand this is currently requested by TS (A1, 38) and coms from the former organisation where the IC4PT was outstanding DSB-M and did the evaluations outside of a safety certificate. This procedure was continued by the independent DSB-S even after the organisational change at the beginning of this year. On the other hand it results from a previous loss of trust in relation to inaccurate or incomplete risk evaluations in the past like Death Train Management (DTM). That means if a minor modification is not considered to have an impact on safety and not to be significant the DSB shall submit the documentation of the evaluation for each CFG to TS against Article 12(3) of “Executive Order on the Approval of Railway Trainsets” (A2, 092).

To capture and identify faults a RIT on-site at the workshop Aarhus has been installed as recommended by Atkins in 2011 (A2, 001). The RIT is in weekly face to face meetings with IC4PT management and engineering to set priorities for important CFGs (A2, 111). The main task of the RIT is capturing and monitoring mainly repetitive faults which arise, identifying and classifying root causes, proposing improvements or corrective measures and monitoring the effectiveness of the implemented improvements. Single faults are being collected but not analysed.

The larger part of the IC4PT engineering staff is located at the DSB headquarters in Høje Tåstrup, the smaller part is located at the workshop in Århus, Sonnesgade. Due to the extensive number of faults, analysing root causes and definition of improvements and solutions the engineering department of the DSB-M is partly involved, too.

Based on the DSB-M organisation as at September 2014 (A2, 016) figure 6-1 shows a sketch of the organisation including the flow for fault handling.

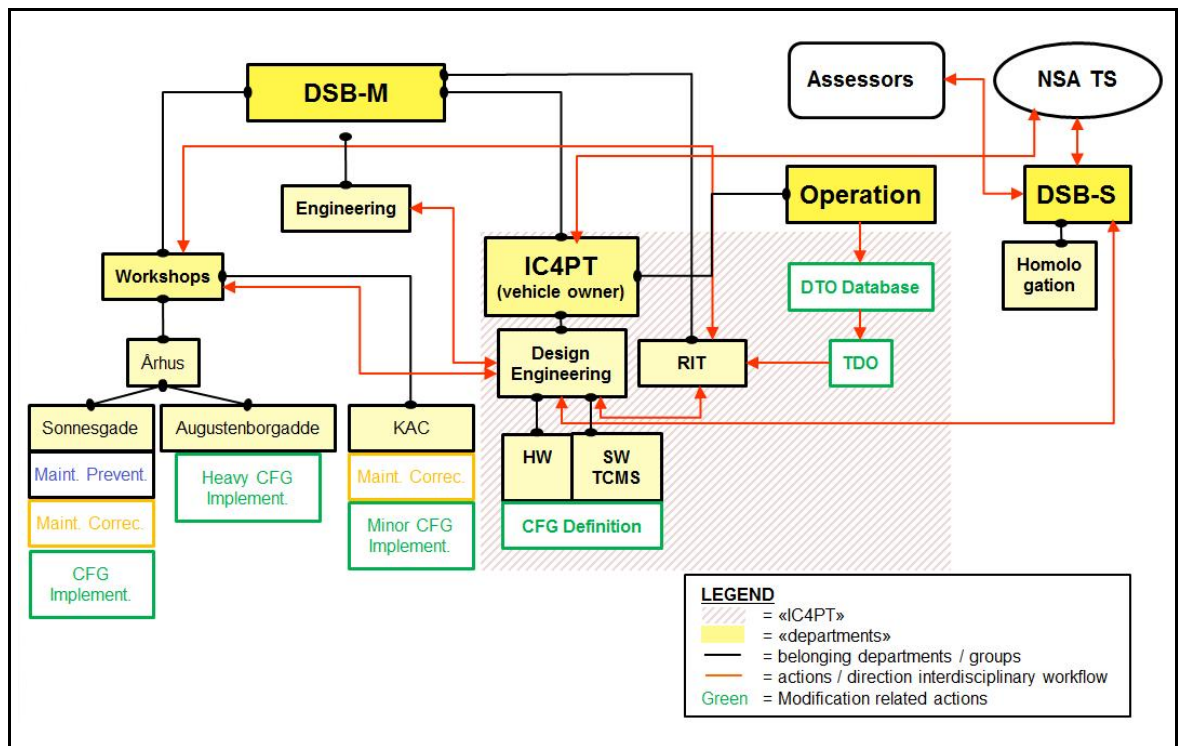

figure 6-1 Organisation including the flow for fault handling IC4/2 trainsets



## 6.2.2 Findings and recommendation

All members of the IC4PT met or interviewed have been enthusiastic about the project.

The number of resources in terms of competent experts especially in system engineering is insufficient.

The already enhanced amount of resource within the RIT is still insufficient to achieve the necessary reliability growth defined by the deployment plan.

### **Recommendations:**

- Improve the collaboration between IC4PT and DSB-S to enhance proper risk evaluation
- Improve the collaboration between IC4PT engineering and workshops which are located at different places
- Additional human resources (experienced driver, system engineers) to reproduce single-faults
- In the event of new errors appearing on complex systems it is recommended that these are handled by special task forces consisting of experienced experts and system engineers

## 7 Appraisal “Quality management”

### 7.1 Package Summary

In terms of the quality management the assessment reveals:

- The CFG processes of the IC4PT QMS is observed as a state-of-the-art QMS for rolling stock
- Follow the defined CFG hardware process P10.10 (A2, 108) of the IC4PT QMS consequently and conscientiously, especially
  - Root cause analysis
  - Definition of requirements (qualitative instead of quantitative)
  - Verification, validation and testing
- Implementation of the activity “compiling FMEA and validation plan” when a CFG is started in the CFG process P10.10 (A2, 108)
- Technical knowledge, adequate planning and processes as well as an adequate level of documentation for software modifications carried out so far, with specific reference to TCMS, have been demonstrated
- DSB might want to further improve the know-how gained through the software transfer team for modifications to be entirely carried out at DSB
- It is recommended that an experienced SW validator is placed within the SW TCMS development team for modifications to be entirely carried out at DSB

### 7.2 Assessment and Findings

#### 7.2.1 Introduction

There are two different QMSs affecting the IC4 fleet. The DSB-M global QMS certified according to ISO 9001:2008 (A3) and the non-certified QMS of the IC4PT. Due to the reorganisation and since the QMS of the IC4PT is much better than the global QMS of DSB-M (especially in the case of handling modifications) current processes are transferring from the QMS of the IC4PT into the certified global QMS of DSB-M.

The aim of the assessment was the analysis and evaluation of the processes and quality management system of both QMSs. The focus has been set to the QMS of the IC4PT especially in regards to the handling of ongoing CFG-related to hardware and software modifications.

## 7.2.2 Global QMS DSB Maintenance

### 7.2.2.1 Practice

PROSE assessed the global DSB-M QMS during an interview with DSB-M quality (A1, 35).

The focus was set to:

- The quality manual
- The compliance and application of their processes in DSB-M
- Process metrics
- Results of external audits
- Supplier management

A further task of the interview was the handling of two different QMS (global QMS & IC4-QMS).

### 7.2.2.2 Impression

The DSB-M QMS is certified according to ISO 9001:2008 (A3), OHSAS 18001:2007 (A4) and ISO 14001:2004 (A5). In general, DSB-M is on a good path. They changed the usability of their quality manual as a consequence of poor application of their processes. The result of that change was better compliance with them and comprehension of them. It may be mentioned positively that the quality manual is clearly laid out in workshop location.

### 7.2.2.3 Findings and recommendations

Ratios are not collected in all processes but DSB-M could disclose their most important process metrics (e.g. MDBF). These will be measured regularly.

In June 2014 DSB-M Quality was assessed by a new certifying body for their ISO 9001:2008 (A3) certification. As a result, DSB-M received five obligations and eight suggestions / hints. However, no aspect was so critical that DSB-M lost the certification, for details see (A2, 403).

In the past, DSB-M executed only a few supplier audits. In 2014 already two supplier audits were performed. DSB-M Quality would like to increase the number of supplier audits. But in general, it seems to be unclear how to handle the quality control of supplier parts.

Several CFG packages have been engineered by the DSB-M engineering. Neither the IC4-QMS nor the global QMS defines how to handle this interdisciplinary exchange between the different departments as well as between the different quality management systems.

#### **Recommendations:**

- DSB-M Quality should provide requirements regarding the evaluation of suppliers and the quality control of supplier parts in order to prevent failures on the (IC4-) trainsets due to insufficient quality of any parts.
- DSB-M Quality should define processes to manage CFGs which were engineered by the DSB-M engineering for the IC4PT.

## 7.2.3 IC4PT QMS - Software TCMS

### 7.2.3.1 Practice

The aim was the analysis and evaluation of processes and quality management for the currently performed software modifications, with an outlook to the challenges and opportunities associated with the introduction of software development at DSB (A2, 404). A two-day meeting has been held at DSB including specific interviews with the DSB personnel in charge for the TCMS. The focus was set on:

- The generic overview of the project structure, organisation and development processes of the software modifications of the TCMS
- The applied processes related to the randomly chosen SW package 2.1
- The application of the specific requirements from the CSM Regulation, CENELEC standards EN50126:1999 (A6) and EN50128:2011 (A7)

Additionally, spot checks on the processes for the SW package MU4 have been performed.

### 7.2.3.2 Impression

DSB have demonstrated

- Technical knowledge, adequate planning and processes as well as an adequate level of documentation to successfully manage potential safety risks related to the TCMS modifications according to the European legislation, namely the Common Safety Measures (CSM-RA, European Regulation 402/2013).
- Adequate planning and processes as well as an adequate level of documentation to ensure that the TCMS modifications fulfil DSB requirements
- TCMS development process, including the phases under DSB suppliers and their sub supplier responsibility, compliant with the relevant technical standards, namely EN50126 (A6) and EN50128 (A7).
- Technical and procedural knowledge to carry out the SW modifications according to the relevant technical standards is ensured by AB and by their sub-supplier Technologie nelle Reti e nei Sistemi (TRS)

Regarding future modifications to be entirely carried out at DSB:

- The fulfilment of the technical requisites from EN50128 (A7) poses different challenges to DSB in the fields of know-how, human resources, SW development processes and SW assessment
- DSB is aware of the most critical above mentioned challenges and have consequently already formulated a project plan to mitigate the impact of the identified challenges on the project

### 7.2.3.3 Findings and recommendations

DSB might want to further improve the know-how gained through the transfer team to fill the current gaps in the compliance of TRS processes with some requirements from EN50128 (A7), as identified by Lloyd's audit report (A2, 365). The improvement of the processes should be documented e.g. in the SW Quality assurance Plan and agreed with the assessor.

A further challenge to the project is identified in the current lack of an experienced SW validator within the TCMS project team, familiar with the validation tasks as specified by EN50128 (A7) for SIL2 functions and specifically experienced to critically judge the TCMS development, its results and the impact of potential issues / shortcomings identified in the processes or in the SW itself. Since validation activities have not been part of the transfer team members' training, it is recommended that an SW validator is placed in the SW development team.

DSB IC4PT is aware that a replacement experienced in the SW development according to EN50128 (A7) could be needed should any transfer team member no longer work on the TCMS project any longer.

With reference to the interfaces with third party companies, the potential risk of delay and extra costs associated to the TCMS development could have been further reduced by following the processes defined in the DSB quality management system, namely the procedure P11 (A2, 109), without the deviations applied to the currently implemented TCMS modifications. Specifically, for future projects involving outsourced SW development, DSB might desire to exhaustively define the requirements, including the safety requirements, before finalizing a SW development contract with a third party company.

## 7.2.4 IC4PT QMS – Hardware

### 7.2.4.1 Practice

IC4PT CFG process P10.10 (A2, 108) has been reviewed on the basis of a closed and an ongoing modification.

### 7.2.4.2 Impression

The reviewed process P10.10 seems to work well for the settlement of CFGs. The sequence of the different process steps is useful. The responsibilities within each CFG are regulated. The process is used for significant and non-significant modifications. This process covers minor and major modifications. In the event that the CFG is not significant, steps 4.5 and 4.6 won't be executed. These steps require an external assessor, which has to be approved by TS and the execution of a hazard workshop.

All CFGs are managed by a software based on a database. By using this software the CFGs can be controlled and monitored (e.g. by their status, costs or validation steps) by the CFG project manager. Given that the usage of the software started in spring 2014, the completeness of the data is not given yet.

This software has the possibility not only to control the CFGs but also to schedule the resources for implementation in advance and to set up a reliability improvement plan.

### 7.2.4.3 Findings and recommendations

The presented and reviewed CFG no. CFG-DSB0133 (frost evacuation water toilet system, with no safety impact or significance) was settled completely according to the guidelines of the process. All required documents are registered, filled out and improvements take effect in the workshop concerned. The CFG has been released according to the staff matrix.

A check of a different ongoing CFG no. CFG-DSB0274 (new blending philosophy of the BCU software 1.16 according to chapter 10.2.2.4) discovered that not all CFGs are executed according to the process and performed as the example mentioned above.

In the process P10.10, the function of an “Integrator” is foreseen. Its function is among others to perform a validation of the defined design solution. Nevertheless a FMEA and a reasonable validation plan should be performed during launching a CFG for major modifications. This shall guarantee a proper overview before starting up the design of a modification.

#### **Recommendations:**

- The performed work shall follow the processes consequently
- Implementation of the activity “compiling FMEA and validation plan” in step 4.2 of the hardware process P10.10

## 8 Appraisal “Workshop Performance”

### 8.1 Package Summary

In terms of the workshop performance the assessment reveals:

- The workshops Sonnesgade and Augustenborggade in Aarhus, as well as Kastrup Copenhagen Airport are well equipped and fit for purpose.
- The capacity of the workshops at Sonnesgade and Augustenborggade are not reached by any means. Both sites can double the amount of work hours with a preparation/ramp-up period of approx. 6 months.
- The workshop management including the clear priority setting, the use of IT to support the process, including the transparent visualization of activity (A02, 195), the work documentation including the trainset configuration (A02, 091) are on a best-in-class level
- The low reliability reflected in the MDBF KPI (A02, 004) of the IC4 fleet generates a high number of unplanned repairs in the workshop. This prevents the workshop from sustainable activity planning and efficiency.
- In comparison with a reference trainset the hours spent for maintenance of IC4 trainsets is 5.3 times higher. But this reflects a temporary situation which will change.
- Due to the poor reliability of the trainset and additional inspections, the maintenance efficiency is low. This leads to high operational costs.

### 8.2 Assessment and Findings

#### 8.2.1 Hours planned and spend 2014

##### Assessment:

	SPM, work hours (1.)	UCM, work hours (2.)	CFG – Implementation, work hours (3.)
IC4 – Planned (4.)	31,855h	123,265h	70,404h
IC4 – Realized	15,104h months 1-9 → 20,138h p.a.	92,109h months 1-9 → 122,812h p.a.	28,945h months 1-9 → 38,593h p.a.
IC2 – Planned (4.)	1,861h	3,720h	33,850h
IC2 – Realized	2,193h months 1-9 → 2,924h p.a.	6,478h months 1-9 → 8,637h p.a.	1,511h months 1-9 → 2,015h p.a.
Remarks: 1. KM-inspection and “stribeliste” orders (Vh02 and vh05) 2. Repair and repair by km-inspection (vh01 and vh03) 3. All sales orders those are also active in eg. operation simulation and test work 4. „Planned ” means included in the financial budget for 2014 prepared in Sept. 2013.			

table 1: Workshop hours planned and realised 2014 (A02, 194)

##### Findings:

- The high amount of repairs / unscheduled corrective maintenance (UCM) prevent sustainable workshop activity planning
- The ratio between schedule preventive maintenance (SPM) and UCM should be at 50/50 instead of 15/85
- In general preventive maintenance is more efficient and cheaper to carry out

## 8.2.2 Comparison current IC 4 efforts with reference trainset

### Assessment:

(1.)	SPM, work hours per year	UCM, work hours per year	Overhauls / Revisions work hours per year (3.)
Reference trainset (2.)	200 hours p.a. and unit	200 hours p.a. and unit	200 hours p.a. and unit
Reference Fleet with 67 units	13,400 hours p.a.	13,400 hours p.a.	13,400 hours p.a.
Efforts IC4 – Realized (table 1)	20,138 hours p.a.	122,812 hours p.a.	Net yet foreseen
Remarks: <ol style="list-style-type: none"> <li>1. Work hours excluding any material costs, any cleaning activities and any vandalism repairs</li> <li>2. Reference trainset profile: EMU, 4 coaches with comparable figures in the operation pattern, the fleet size and trainset systems, as well as year of first commissioning.<sup>1</sup></li> <li>3. Overhauls / Revisions: are carried out approx. every 6<sup>th</sup> year and do not contain modernisations</li> </ol>			

**table 2:** Workshop Hours, reference trainset

### Findings:

- The current hours spent for maintenance of (SPM and UCM) the IC4 fleet is 5.3 times higher than on a reference fleet.

## 8.2.3 Compare workshop capacity with reference trainset

To assess the workshop capacity, the working hours for the maintenance of the reference trainset are taken as an assumption for the IC4 and IC2 trainsets after the goals defined in the deployment plan have been achieved.

### Assessment:

(1.)	SPM, work hours	UCM, work hours	Overhauls / Revisions work (3.)
EMU (2.) as placeholder IC4	200 hours p.a.	200 hours p.a.	200 hours p.a.
EMU (2.) reduced by 25% as placeholder IC2	150 hours p.a.	150 hours p.a.	150 hours p.a.
Reference Fleet with 82 units, as placeholder IC4	16,400 hours p.a.	16,400 hours p.a.	16,400 hours p.a.
Reference Fleet with 23 units, as placeholder IC2	3,450 hours p.a.	3,450 hours p.a.	3,450 hours p.a.
Total Workshop performance required	19,850 hours p.a.	19,850 hours p.a.	19,850 hours p.a.
Remarks: <ol style="list-style-type: none"> <li>1. Work hours excluding any material costs, any cleaning activities and any vandalism repairs</li> <li>2. Trainset profile: EMU, 4 coaches with comparable figures in the operation pattern, the fleet size and trainset systems as well as year of first commissioning.</li> <li>3. Overhauls / Revisions: are carried out approx. every 6<sup>th</sup> year and do not contain</li> </ol>			

**table 3:** Complete Workshop performance, reference trainset

<sup>1</sup> Depending on how workshop hours are deviated between preventive and curative actions the figures may look different. The assessment team has compared with several fleets. Finally the fleet which is the most comparable has been chosen and a risk uplift of 10% was added on the reference figures.



**Findings:**

- The available workshop capacities are sufficient to maintain the whole IC4 and IC2 fleet, once the trainsets are performing on the expected reliability level (MDBF>20,000 km). However due to operational aspects it might be better to carry out maintenance at multiple sites in order to reduce unnecessary trainset transports.
- The current maintenance handbook for the IC4 (A02, 197) holds for the Mega meter (Mm) inspections 15, 30, 45, 60, 75, 90, 105, 120, 135, 150, 165, 180Mm a total of 339 hours. Since the maintenance handbook is just about to be optimised the number of hours from the maintenance handbook of the IC4 trainset compared to the number of preventive hours for the reference trainset might be in line.

**8.2.4 Site Survey Workshop Sonnesgade, Aarhus**

The site survey was carried out on 9 October 2014.

**Site Overview:**

figure 8-1: Site Overview Sonnesgade, Aarhus (maps.google.ch)

**Infrastructure:**

The workshop is equipped with:

- 6 inside tracks IC4 or IC2 trainset
  - Trainset lifting installation on 3 tracks
  - Crane facility on 2 tracks
  - Drainage facility for emptying toilets, as well as diesel tank emptying pump on all tracks.
- 5 outside tracks IC4 or IC2 trainset and 1 outside track IC2 trainset only
  - Trainset power support
  - Mobile platforms to board train for inside repairs
  - Water supply to fill toilet tanks
  - Trainset power support
  - Mobile platforms to board train for inside repairs
  - Water supply to fill toilet tanks

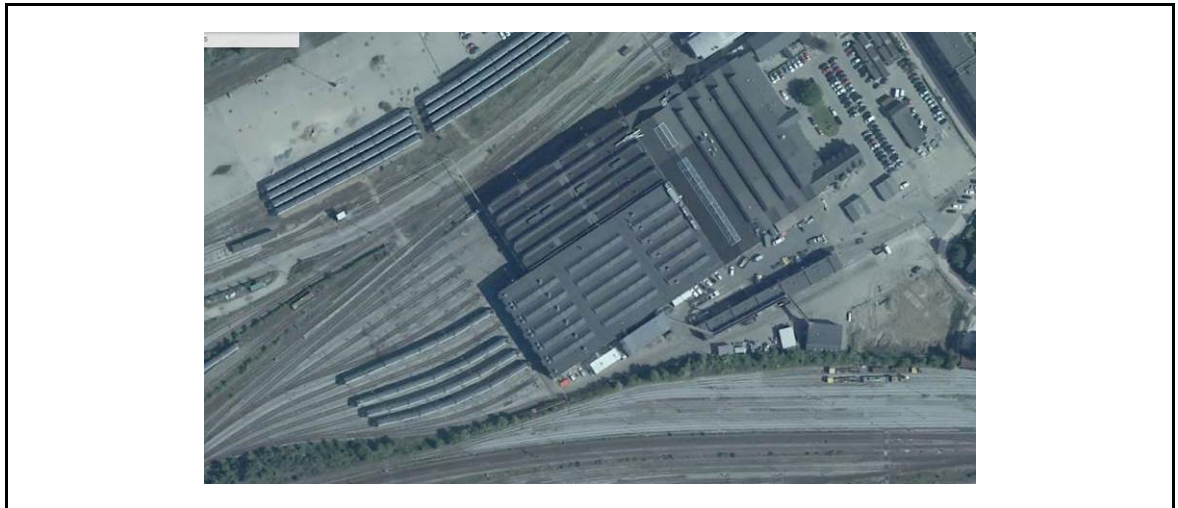
**Planning:**

- There is planning done outside of the workshop for the mega mileage inspections
- There is weekly planning (A02, 196) in the workshop done including what, where and whom (track, team and work content)
- There is daily planning done including the same content as the weekly plan

**Shift Model:**

- The current shift plan has three shifts. The morning shift 05:00-13:00 with a staffing level of between 30-50 craftsmen, the afternoon shift with a staffing level of 6 and night shift with a staffing level of 3 craftsmen (A2, 195).

**Findings:**

- The workshop Sonnesgade fits its purpose but the facility capacity not reached by any means. If required, the workshop could produce double the amount of hours with a preparation/ramp up period of approx. 6 months
- Processes, IT support, work documentation, transparency, trainset configuration management are on a best-in-class level
- Integration of workshop management, trainset maintenance, component overhauling, spare part management is closed and provides a good basis for common identification and improvement of the maintenance
- Once the suboptimal and time-consuming maintenance tasks (ex. frequent inspections of wheel profile, exchange of half used wheels due to not adjustable power pack software, etc.) can be eliminated, approx. 40% of the current work hours can be spent on more useful maintenance
- The nightshift is primarily used to do nursing during takeover of trainsets by the drivers. It is understood that this cost-intensive action is actually necessary to reach the availability goal.

**Additional observations:**

- During the workshop survey trainset have not been moved during the shift. Hence once the maintenance was finished on one trainset it was still parked inside. One reason for this is a suboptimal situation in the trainset disposition, meaning due to the parked trainset outside just in front of the door the trainset shunting requires more than one driver. In addition the workshop personnel are limited in driving the trains in and out of site. The best solution would be one separate drive out track for two inside tracks in order to drive out without moving. Alternatively trains with a level of work which does not fill out the full shift should not be blocked with a trainset on the outside track.
- The trainset lifting and the driving / parking of trainsets cannot be performed in an efficient way due to limitations in who is allowed to perform these special tasks.

## 8.2.5 Site Survey Workshop Augustenborggade, Aarhus

The site survey was carried out on 10 October 2014.

### Site Overview:



figure 8-2: Site Overview Augustenborggade, Aarhus (maps.google.ch)

### Infrastructure:

The workshop is equipped with:

- 2 inside tracks IC4 or IC2, the installations are prepared to do the CFGs currently in implementation phase and will be adopted according to the upcoming CFGs (ex. Lifting facilities).
- 1 inside track IC4 or IC2 in the “preparation for painting” hall
- 3 outside tracks IC4 or IC2

### Planning:

- There is planning done (A02, 192) outside of the workshop for the major/focus CFGs on a weekly basis
- Currently 60 % of the performed work is CFG’s (planned), 40% are unplanned repairs
- After leaving Augustenborggade the trainsets are always sent to Sonnesgade for the remaining maintenance tasks and preparation for handover to operations

### Shift Model:

- The workshop is operated on a one shift model beginning at 05:30 with a meeting at 07:45. It is based on 37h per week with a 1h preparation block.

### Findings:

- The workshop Augustenborggade fits the purpose but the facility capacity is not reached by any means. If required, the workshop can produce double the amount of hours with a preparation/ramp-up period of approx. 6 months
- Although the building structure is older and more narrow, the workshop is well equipped and fits the purpose.

## 8.2.6 Site Survey Workshop Kastrup Airport Copenhagen

The site survey was carried out on 30 October 2014.

### Site Overview:



figure 8-3: Site Overview Kastrup Airport Copenhagen (maps.google.ch)

### Infrastructure:

The workshop is equipped with:

- 2x 400m inside track for trainset preparation tasks
- 1x 100m inside track for repair including lifting facilities
- A huge outside trainset parking area
- Currently the 100m repair track is used 7x24h and two 100m slots are used for IC4 maintenance 07:00-22:00

### Planning:

- There is planning done outside of the workshop for the mega mileage inspections.
- There is weekly planning (A02, 196) in the workshop done including what, where and whom (track, team and work content)
- There is daily planning done including the same content as the weekly plan

### Shift Model:

- The plant is been used 7x24h with a high usage during the night time when the long distance trainsets are being prepared for the next day.

### Findings:

- The KAC workshop is highly focused on train preparation. Usually trains are being cleaned inside and outside, filled up with water and fuelling and smaller repairs are being carried out in a 2-4h timeframe.
- The workshop is very well equipped and fits the purpose.
- Due to the current operating pattern the workshop in KAC suffers from an insufficient workload of IC4 maintenance, especially on weekend days.
- The know-how exchange between the main workshop in Arhus and KAC is being carried out on a regular basis.
- The deployment plan is unknown in the workshop KAC

## 9 Appraisal “MDBF Improvement and goals”

### 9.1 Package Summary

Regarding the MDBF improvements and goals the assessment shows:

- The MDBF goals set by the deployment plan (A2, 015) are realistic in comparison with other vehicles and operators
- Currently the MDBF shown on a monthly basis (A2, 015) is below the goal set. This is due to the current focus of the IC4 program which is set to eliminate design errors and enable train functionality as per specification level as well as the workshop which has a clear focus on availability of trainsets. However the MDBF of 13,687 km (A2, 406) only for November 2014 shows a positive tendency.
- The total MDBF improvement potential addressed in CFGs and RIT reports is 2,473 km (A2, 161) which is much too low.
- Hence it is recommended that the engineering and RIT expand as well as double up on the number of crew implementing CFGs.
- To improve the reporting of failure messages, cross-functional teams including drivers, engineering (hardware, software) and workshop staff shall be established.
- After the known design errors are eliminated, the train functionalities are enabled. Then the focus for the IC4 program needs to be on the improvement of the reliability, hence MDBF. For released CFGs the rollout needs to be planned and implemented as fast as possible within the limits set by the workshop capacity in order to navigate out of the current situation fast.

### 9.2 Assessment and Findings

- By end of the year 2014 about one third of the total mileage of the fleet has been performed within 2014 which reflects an increased operation performance (A2, 030).
- It is likely that by the end of the year 2014 about 20 trainsets will collect 100,000 km each (A2, 030). This basis is solid enough for key performance indicators (KPI).
- The MDBF goals set by the deployment plan are realistic compared to other fleet and operators (A2, 015).
- Currently the reliability improvements are not as much of a priority as the availability (Focus of the workshop) and the improvement of the functionalities. (Focus of the IC4PT).
- Since April 2014 the reliability improvement goals have not been reached. There is no tendency in the monthly report of MDBF (A2, 111) to achieve the goals set in the deployment plan.
- The MDBF baseline calculated by RIT as average of the fleet (January till August 2014) is 5,949 km (A2, 161) for operation in regional and long distance traffic. The MDBF goal as per the deployment plan should be 7,260 km in January 2014 and increase to 9,077 km in August 2014 (A2, 015).
- The MDBF reached for November 2014 is 13,687 km (A2, 406).

- The current improvement potential addressed by the RIT is 2,473 km. This reflects all known CFG's and RIT reports (A2, 161).
- Currently there are two implementation methods for CFGs:
  - Packages, currently “coupling” on two trainsets per week scheduled in Augustenborggade (A2, 192)
  - During regular maintenance
- The IC4 program is focusing on “Top 10” CFGs during design and implementation phase (A2, 111)
- Since the potential addressed (A2, 161) is not sufficient and the design and implementation is in some cases rather slow, both areas need to be developed. It is most important to get out of this critical situation fast. Hence enlargement of the engineering and RIT is recommended as well as doubling up the crew implementing CFGs.
- To improve the reporting of failure messages, cross-functional teams including drivers, engineering (hardware, software) and workshop staff shall be established. This is to ensure high quality of failure messages and close cooperation in the investigation and solution finding.
- After successful validation, and only then, CFGs need to be rolled out over the entire fleet as fast as possible in order to earn the savings and release the workshop from UCM.

Although five IC4 trainsets are taken apart for spare parts, the goal of the deployment plan to have 74 trainsets in operation in 2019 is not affected. Furthermore, today no decision has to be made, if in the end all 82 trainsets shall be taken into operation. This decision can be made at a later stage, when the financial basis (CAPEX, OPEX) is sustainable.

Since April 2014 on all trainsets at least one CFG has been implemented; in August and September 2014 at least one CFG on 58 trainsets.

On a large number of trainsets a high amount of CFGs are already implemented. Nevertheless no time schedule for the CFG implementation on the fleet exists. Excluded from this statement is the gaiter package, where an implementation plan is in place for the first 20 trainsets. This leads to the fact, that each trainset has its individual current status of CFGs implemented as well as a reactive implementation; reactive in the sense that CFGs are implemented when the trainsets are in the workshop. However the rollout of CFGs is under control due to a transparent configuration management. Due to the individual trainset configuration status, error finding and RCA is more difficult and time consuming. Therefore it is recommended that implementation is increased in order that as soon as a CFG is released for implementation a rollout plan is defined and the implementation on the entire fleet is performed within a short time-frame.

## 10 Appraisal “Technical risk assessment of main functions”

### 10.1 Package Summary

This technical assessment does cover all currently addressed issues, but future issues could occur (e.g. fatigue failures in structures which could occur at higher mileages). Due to reasonable suspicion also other systems fitted to trainsets might be incompletely engineered.

Regarding the Technical risk assessment on main functions the assessment shows:

- Coupling multiple traction
  - The TCMS software version required for operation in fixed coupled double traction is not yet approved by the TS. Therefore the approval shall have the highest intension within the IC4PT.
  - Front gaiter modification seems to be ok but is not fully validated, however the not performed tests will not prevent from fixed double traction.
  - Additional measures can't be excluded, because not all modification on the coupling system are well tested
  - The physical modification of 20 trains for be able to operate in fixed coupled double traction by the 14 December 2014 are on time
- Brake
  - Two major failures in the system design where revealed during the investigation after Marslev event
  - The measures defined and implemented by DSB seem adapted in order to get rid of the speed limitation. The results of the validation tests are not known at the edition date of this report.
  - A validation plan of the new blending parameters in the BCU software has to be set up.
  - The brake system of the IC4/2 trainsets is complex with numerous monitoring equipment and redundancies. A deep investigation of the system is advised with the goal to identify the possibilities to increase the reliability of the system.

- Axle box housing:
  - Insufficient RCA based only on statistic
  - Measures defined by DSB are pointing in the right direction, but there is a risk due to the insufficient RCA that the measures are not sufficient. This may affect also the safety-relevant upper part of axle box housing
  - FE Analysis did not considered the current higher weight balance (difference > 1 tons per axle)
  - Lowering the rail guard to avoid collisions with objects is recommended
  - Wheel maintenance manual should consider the EN15313 to control the wheel out-of-roundness
- Power Pack
  - 25 CFGs have been defined on the power pack. 4 of them are critical.
  - Since some of the actual issues can have quickly drastic consequences it is recommended to setup a task force that will be able to investigate RCA of current break downs of crankshaft in the engine and implement solutions in a short time.
  - A detailed technical assessment of the power pack is recommended. For the safe development of the program it is mandatory to strengthen the technical basis of the power pack by detecting possible failures before they appear during operation.
  - 5 IC4 trainsets shall be designated to collect mileages. Therefore this trainsets shall be used in operation prioritized. The aim is to collect mileages in a short time to have an indication how the rest of the fleet will perform at later stage.

## 10.2 Assessment and Findings

### 10.2.1 Coupling multiple traction

#### 10.2.1.1 Introduction

According to the deployment plan the functionality of operation with coupled trains shall be achieved in two steps (A2, 015):

- Running with fixed coupled IC4 trainsets first quarter 2014 (phase 2)
- Running with coupling/decoupling in operation first quarter 2017 (phase 6)

Currently DSB Operation (DSB-O) plans to operate one trainset with two IC4 trainsets fixed coupled in December 2014 (A1, 22). According to DSB-M 20 trainsets shall be upgraded with the coupler package by December 2014 (A2, 111).



Based on these the overdue date for running with fixed coupled IC4 trainsets is seen as replaced by the goal to have 20 trainset ready for fixed coupled operation in December 2014. It is therefore recommended to update the deployment plan.

Despite the physical modifications of the coupler itself, also the TCMS and the BCU software needs to be updated to run fixed coupled in operation.

The defined measures for physical modifications of the coupler are defined in different CFGs:

- CFG0113: Modification on RECO Antenna
- CFG0161: Modification of cable support
- CFG0165: Adjusting of pressure switch
- CFG0167: Front gaiter
- CFG0168: Front gaiter, electrical change
- CFG0169: Decoupling electrical coupler
- CFG0280: Coupler overhaul (Includes exchange of the bearing (A2, 188))

The focus of this technical assessment has been set to the critical CFGs:

- CFG0113: Modification on the RECO Antenna (A2, 329)
- CFG0167: Front gaiter (A2, 332)
- CFG0168: Front gaiter, electrical change (A2, 333)
- CFG0169: Decoupling electrical coupler (A2, 334)
- CFG0280: Coupler overhaul (A1, 27)

In this list not considered are the modifications of the TC and BCU software which are also required for operating in multiple traction.

### **10.2.1.2 Critical CFGs**

#### **10.2.1.2.1 Modification on the RECO Antenna - CFG-DSB0113**

A retracted coupler of a not occupied trainset can be extracted from the occupied trainset over the remote control system RECO by the train driver.

This system didn't work as specified, because the communication between the two trainsets to be coupled was disturbed. Tests performed by Blueprint have shown that the signal of the RECO antenna was disturbed by the windshield (A2, 184), because the antenna was located on the upper part of the cab behind the windshield.

Based on this finding, the RECO antenna has been replaced to a position in the front of the cab. Additionally a different antenna type has been defined.

After this modification, no type test has been performed with the new RECO antenna placed at the new position. With considering the test with the old RECO antenna moved to a location close to the currently used position, which shows the functionality even for a distance between the trains of 50m and the tests performed by Blueprint (with a different antenna type), which shows an increase of the signal of about 20dB between the old and

the new location, the functionality of the RECO system can be seen as verified (A2, 183/184/191).

The good function of the remote control system with a distance between the trains of more than 20 meters could be witnessed during the coupling tests performed on the 9 October 2014 (A1, 29).

#### 10.2.1.2.2 Front gaiter - CFG-DSB0167 / CFG-DSB0168

The IC4 trainset is equipped with an automatic front coupler system at each end. If the trainset is not coupled, the front coupler is retracted and protected by sliding covers. During coupling, the covers retract inside and the coupler extracts. To guarantee the safe operation of this coupling and uncoupling process, the system is supervised by sensors and controlled by the TC. Beside the mechanical connection, the electrical signals are connected by a separated electrical box, placed above the mechanical coupler.

As stated in the Atkins report the coupling system is very fault-prone and therefore the recommendation for reducing the complexity of the system has been given by Atkins (A2, 001).

The coupling system has been analysed by DSB and it was decided, that the sliding covers shall be replaced by a fixed gaiter solution to reduce the complexity of the coupling system. Therefore the moving parts including the supervision have been removed, except the extension of the coupler itself. A complete redesign of the coupler would be required to drive uncoupled with the coupler extended because the coupler is not designed for this. The redesign for the coupler has been dismissed.

Thus, several actors and sensor fall away and the control within the TC software has to be removed. This update of the TC software has been rejected (A1, 27) and therefore an electrical modification has been specified in the CFG-DSB0168 to replace the signals of the missing components (A2, 223). That means the electrical change is only required to simulate to the TC software that the sliding covers are still available.

Although this is not the preferred way to do it, the solution is proper and fulfils the requirement. The update of the TC software is planned at a later stage.



figure 10-1: New gaiter; left picture: coupler retracted; right picture: coupler extracted (A2, 222)

For the new gaiter a requirement specification has been elaborated and a public tender announced (A2, 095). During January 2013 IC4 trainsets have been equipped and tested with three prototype gaiters each produced by one of three different suppliers (A2, 154). The gaiter produced by Dellner has been selected by DSB (A2, 152). Dellner has similar gaiters already in operation in Sweden and Norway for over 10 years (A2, 335).

After the implementation of the CFGs related to the coupler on trainset 5602, a static extract/retract test has been carried out. Within 1,000 cycles of extract/retracts, no failure occurred (A2, 213/336).

The same test has been performed after the implementation on trainset 5868. Within 1,000 cycles of extract/retracts, 128 failures during extraction occurred (A2, 212). At this state DSB wasn't aware of the problem with the bearing (see 10.2.1.2.4). This test has not been repeated with the modified bearing so far (A1, 27).

Currently the traction is blocked, in case of the supervision of the coupler detects inconsistent signals (e.g. closed cover although the coupler is safely extracted). This traction block is removed in the TCMS Version 2.1 (ICQTCMS-582).

#### **10.2.1.2.3 Decoupling electrical box - CFG-DSB0169**

The electrical boxes of the couplers can't be separated in up to 20-30% of the decoupling cases. Currently the electrical box of the trainset which initialised the decoupling retracts only. The other electrical box retracts later.

Each electrical box is moved by a cylinder and guided by two rods. DSB assumes that during driving the electrical coupler boxes are moved slightly out of centre and are wedged. This blocks the retraction of the box if only one box is moving backward. DSB has concluded, that the retraction of both boxes should be simultaneously, because in this case both boxes are centralised at the same time. Dellner also suggests retracting both electrical box simultaneously, but without giving a reason for that (A2, 097).

The defined HW solution activates the cylinder on the passive trainset in parallel to the cylinder in the active trainset (A2, 181). The realisation of the solution is in a common way.

The root cause for the blocked decoupling of the electrical boxes isn't clearly identified. Therefore a risk exists, that the defined measure doesn't solve the problem.

#### 10.2.1.2.4 Coupler overhaul (New Bearing) - CFG-DSB0280

The extraction and retraction of the coupler is guided by two bearings (bushings) (7, 8 in figure 10-2) that are positioned between the buffer tube (1 in figure 10-2) and the hydraulic buffer (2 in figure 10-2) within the Dellner coupler.

In March 2014 DSB reports, that the outer diameter of the bearing is bigger than the inner diameter of the pipe, where the bearings are placed in (A2, 210).

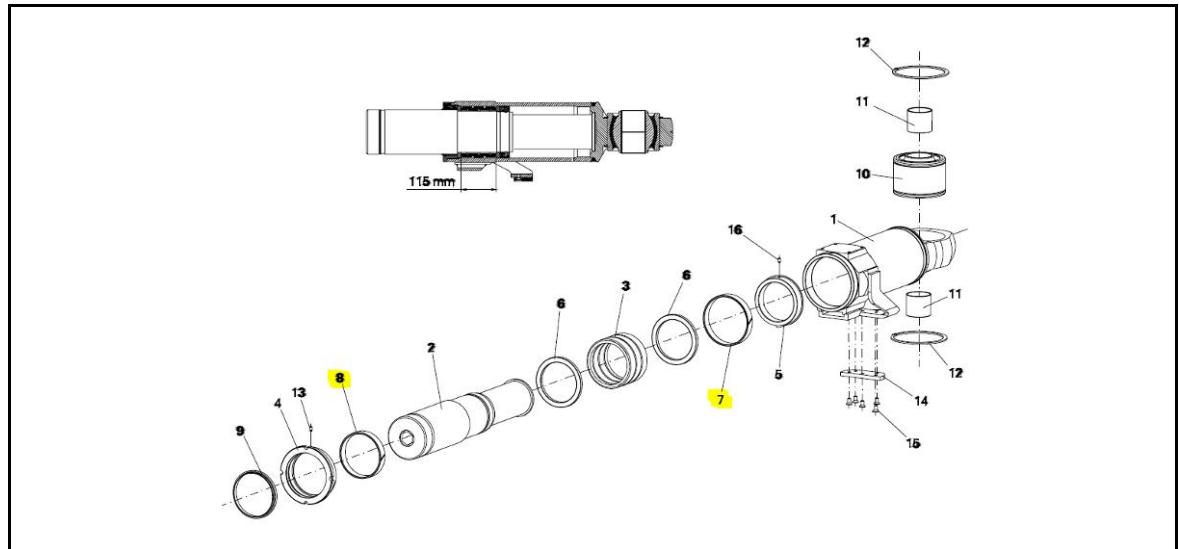

figure 10-2: Overview of the coupler buffer with bearings yellow marked (7, 8) (A2, 159)

Dellner stated that the bearing is oversized because of some expansion as the bearings have the potential to take on some moisture. Since the coupler has been placed for a longer time under unknown conditions, Dellner stated that the moisture could be the potential root cause (A2, 211).

DSB and Dellner agreed on an overhaul of the coupler because these can be realised in a short time. As part of this overhaul the bearings are replaced by different bearings defined by Dellner.

Since Dellner doesn't provide DSB further information about the material of the bearing nor about the tests, DSB has no evidences, to assure, that the problem is solved by the new bearings (A2, 338).

It is recommended to perform a verification, to have an evidence, that the problem is solved.

Compared with the old coupler protection, the bearing itself is now better protected due to the new gaiter, which protections the moving part of the coupler also in the extended position.

#### 10.2.1.2.5 Implementation of modifications regarding coupler

According to the planning two IC4 trainsets per week can be improved by the modifications relating the coupler (A2, 192). The capacity is enough to improve 29 IC4 trainsets till end of 2014, but currently the modification is limited to 20 IC4 trainsets (A2, 111). At the 8 October 2014, 16 trains have been rebuilt (A2, 188). This are 3 trains ahead the schedule.

Therefore no risk can be seen, that not 20 trains are equipped with the modifications related to the coupler in week 50/2014.

#### 10.2.1.2.6 Validation and verification

The type test of the modification related to the coupler has been carried out statically with the trainsets 02 and 68. All tests have been approved under reservation of two failures the TC (A2, 215/216/217/218):

- One affects the communication between the RECO Antenna and the TC
- One affects only

These failures are still under investigation and up to now the drivers are instructed to repeat the procedure after a drop out (A2, 336).

By mid of October, no coupling / decoupling tests after a test run of a coupled trainsets on the line have been performed (A1, 27). These tests are designated to be done before commercial operation in December, but not specified or planned in the beginning of October (A1, 27). Therefore the verification of the modification isn't finalised.

By mid of October no dedicated tests for the verification of the overhauled coupler have been performed by DSB, especially regarding the new bearing. However every overhauled coupler is tested as part of the serial test after the implementation of the modification related to the coupler (A2, 369).

This absence of test doesn't have an impact to the reliability of the fixed coupled trainset, because the trains are coupled only in maintenance environment and only a few times. But there is a risk of the availability.

Since there is enough time left until phase 6, no risk regarding time is identified for coupling / decoupling in operation as well. But there is a risk from financial point of view, if the coupling / decoupling after a run on line is not successfully and additional measures have to be defined. Basically this can be seen regarding the electrical box and the new gaiter because the movement of the coupler during operation has an impact to these two parts. Additionally the assumption of the root cause regarding the simultaneously retraction of the electrical boxes is not verified yet.

To reduce the amount of money spent to a solution that doesn't bring the specified functionality, it is recommended to finalise the verification and validation of the taken measures in a short time.

After the successful verification and validation, experiences in operation shall be acquired. This is not limited to experience from technical point of view, but also from operational point of view.

The serial test of the modifications regarding the coupler specifies 20 times coupling / decoupling for each coupler: 10 times as the coupler on the unoccupied trainset, 10 times as the coupler on the occupied trainset (A2, 220). This serial test on trainset 30 has been carried out successfully for both couplers on trainset 30 (A2, 219).

The proper functionality of the modified coupling system has been observed during the coupling test on the 9 October 2014 in Aarhus (A1, 29). The coupling / decoupling has been performed three times without any problems between the IC4 trainsets 82 and 60. The first

extraction of the coupler of trainset 82 has been initialised by the trainset 60 in distance of more than 20 m to the trainset 82. The trains have not been moved in coupled status.

#### 10.2.1.2.7 Homologation

The modifications related to the coupling system are stated by DSB-S as not significant. This is also agreed by TS (A2, 221). Based on these the trains with the modified coupler are approved for operation in traffic.

The replacement of the bearing is part of the regular coupler overhaul for DSB. Thus DSB didn't classify this as a change of the construction although the documentation is changed. Therefore no action regarding homologation has been taken (A2, 350). The bearing is used only for extracting/retracting the coupler, not for towing or pulling.

#### 10.2.1.3 Open findings

As mentioned in chapter 10.2.1.2, some issues regarding the communication between the RECO system and the TC software and the TC software itself are undue or the status not known by the RIT (A2, 188):

- RECO stops the sequence (Reason unknown)
- Timeout in RECO and TC Software (A2, 188)
- No retraction in the slave trainset (A2, 188)

These issues do not have an impact to the reliability of the fixed coupled trainset, because the trains are only coupled in maintenance environment. But there is a risk of the availability, in case it took longer to couple a trainset.

Since there is enough time left until phase 6, also no risk regarding time is identified for coupling/decoupling in operation. The evidences today show that the issues can be solved by SW modification, therefore the amount of work for that can be covered by the IC4 program.

Recommendation:

- Soon investigation on the trainset with all involved parties (TCMS, RECO system, driver)

#### 10.2.1.4 TCMS software

In Mai 2014 the operation in multiple traction has been stopped because a possible malfunction in multiple traction has been found during the development of the TCMS software MU4. The malfunction is that there could be some problems in case the gateway communication between coupled trainset is lost (issue known as "dead train") (A2, 377). At that time, the TCMS software packages 2.1 and 2.2a were already finalised and therefore this malfunction is not fixed in these versions. Thus the malfunction has been corrected in the TCMS version Mu4 which was not finalised at that time. Besides the correction of the malfunction, also measures have been implemented, to be able to handle a disconnected gateway, if this should occur (A2, 085/086/087). In addition the BCU software has to be updated, to ensure that in case of a disconnected gateway

communication the brake force of the “dead train” is still available. The implementation is defined for the BCU version 1.16 (A2, 361).

The homologation for the TCMS version 2.1 is limited to operation in single traction. To be able to operate in multiple traction, the version Mu4 has to be approved by TS. At the 13 November 2014, the Mu4 is not approved by TS. This is in line with the time schedule defined by DSB (A2, 367). According to this timeline, the approved TCMS package Mu4 is planned to be implemented on the fleet between the 12 and 14 December 2014.

At the 3 November 2014, a meeting with TS about the next step has been held, but nothing finally agreed (A2, 368).

Recommendation:

- Highest intension within the IC4PT for the homologation of the Mu4 Software package

## 10.2.2 Brake

### 10.2.2.1 Introduction

The brake system of the IC4 suffers two kinds of problem. The first one is a speed restriction because of bad performance of the system on slippery rail, which has a very dramatic impact on the operation of the trainsets and leads to a speed reduction. The second problem is the amount of failures of several system components leading to a poor reliability of the system.

### 10.2.2.2 History and present status

The IC4/2 trainsets are homologated for a maximal speed of 180 km/h. The required brake % for this speed is 170% without magnetic track brake and it is the value set in the Automatic Train Control System (ATC). Currently the brake system achieves 186% (A2, 389/390). The braking power of the IC4/2 is therefore adapted to the operation. The WSP control is done independently for each axle, except the axles 5 and 6 of the trailer bogie which are commonly controlled by one Brake Control Unit (BCU).

On the 7 November 2011 the "Marslev" event occurred. Marslev is a portion of the network, where normally no slippery rails and therefore no sliding are expected. An IC4 trainset failed to stop at a stop signal. This caused TS to prohibit the IC4 from running operation until the root cause is found to solve the problem.

Finally the operation of the IC4 was allowed to start again under the following specific interim restrictions (A2, 129):

- Braking percentage reduced from 170% to 130%, which reduces the maximum operating speed to 175 km/h. This is an action chosen by DSB to increase the safety of the braking system: it enables the ATC emergency brake earlier.
- Axle 5 is not braked. This reduces the braking percentage to 153%. This is an action chosen by DSB to ensure that ATC has always a safe accurate position (reference axle).
- Speed restriction of 140 km/h for the period from 1 October to 30 November. The restriction is initiated by the TS and aims to reduce the impact of high slippery rail in the autumn period.

This leads to the current speed restriction of 169 km/h except for the autumn period. All of these restrictions have an important impact on the operation of the IC4 and the fulfilment of the deployment plan.

To retract the speed restrictions DSB has been requested to perform dynamic tests with WSP system on IC4 (A2, 394). In order to meet the requirements from the TS, the WSP-system was tested according to a test specification and a test program that fulfils the requirement of standards UIC 451-05 2<sup>nd</sup> edition and EN 15595:2009+A1 (A2, 394). The dynamic tests were performed with IC4 on 23 and 24 August 2014 and 20 and 21 September 2014 between Vojens and Rodekro.

The results and assessment of these tests are not known per end of November 2014.



On 6 January 2014 an IC4PT brake task force (A2, 129) has been setup. The aim of this task force was to get rid of the three operating restrictions limiting the maximal speed. It has also to be mentioned that additionally the TS (A2, 129) requires the magnetic track brakes to be in service for the operation even if they are not included neither in the safety brake performance nor for the calculation of the brake percentage.

### 10.2.2.3 Root cause analysis of the IC4PT brake task force

Since setup of the IC4PT brake task force two failures of the brake system were detected by several investigations of the brake system:

- Wrong piping of the parking anticomponent device
- Wrong blending philosophy

#### 10.2.2.3.1 Wrong piping of the parking brake anticomponent device

Firstly a wrong piping of the parking brake results in blocked wheels during braking. The parking brake shall be automatically applied when the pressure of the brake pipe and of the brake cylinder full fill the prerequisite as shown in the table 4 while the main pipe pressure is greater than 5 bar (A2, 038).

Brake Pipe Pressure	Brake Cylinder Pressure	PARKING BRAKE
< threshold (2,7 bar $\pm$ 0,3)	< threshold (2 bar +0,2;-0,5)	<i>Applied</i>
< threshold (2,7 bar $\pm$ 0,3)	> threshold (2 bar +0,2;-0,5)	<i>Not Applied</i>
> threshold (2,7 bar $\pm$ 0,3)	< threshold (2 bar +0,2;-0,5)	<i>Not Applied</i>
> threshold (2,7 bar $\pm$ 0,3)	> threshold (2 bar +0,2;-0,5)	<i>Not Applied</i>

table 4: Appliance conditions of the parking brake (A2, 038)

Because of a failure in the piping the anticomponent device received the cylinder pressure from the WSP-valve outlet instead of receiving it from the integrated relay valve outlet. As a result during braking on slippery rail, the parking brake was applied resulting in blocked wheels and flats.

This failure has been had bad consequences on the braking performance on slippery rail during the Marslev: the wheels locked easily because of the release of the parking brake as soon as the WSP valve reduced the cylinder pressure below 2 bar (+0.2/-0.5) during emergency brake (brake pipe pressure < 3.8 bar). Therefore the release of the parking brake on some wheels during the Marslev event cannot be excluded which would provide a better explanation for the long braking distances because it has been stated that wheels were blocked (A2, 129).

#### 10.2.2.3.2 Wrong blending behaviour

The blending function allows an optimization of the brake force repartition between hydrodynamic brake (HDB) and pneumatic brake on a single bogie. The HDB is prioritised used in order to minimize the heating and the wear of the brake discs and the brake pads (A2, 038). Due to the trailer axles are not equipped with HDB the blending is improved with an additional cross blending function optimizing the brake force repartition between all axles on the trainset level with priority to the HDB.

In case of braking on a slippery rail the HDB is switched off when wheel sliding is detected by the system. In this case the HDB force is replaced by additional pneumatic brake forces. During several braking tests on slippery rails a wrong behaviour of the blending has been detected. The system didn't always apply the additional pneumatic braking forces in a

correct way when the HDB was disabled. As a result, the brake forces were applied mainly to the trailer axles only (A2, 129).

#### 10.2.2.4 Measures by the IC4PT brake task force

##### 10.2.2.4.1 Wrong piping of the parking brake anticompound device

The failures in brake piping were corrected according to CFG-DSB0022 (A2, 113) which has been already finished on the last trainset in March 2014.

##### 10.2.2.4.2 New blending philosophy

The following diagram figure 10-3 shows the current repartition of the brake effort in tare load according to the speed (A2, 046).

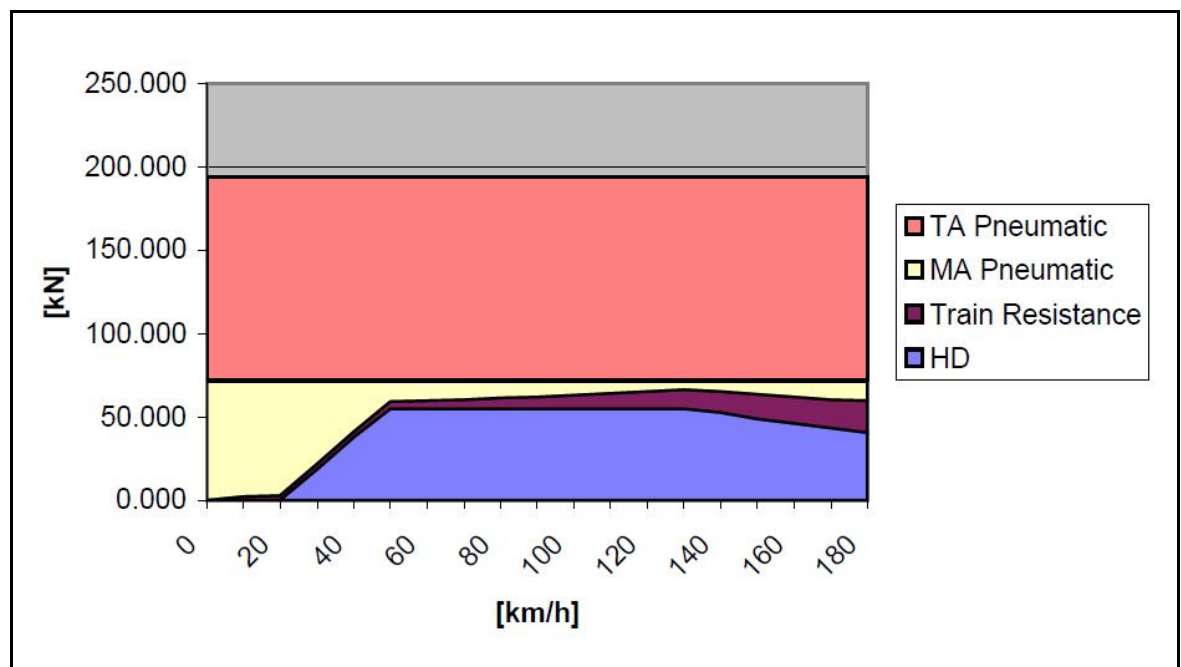
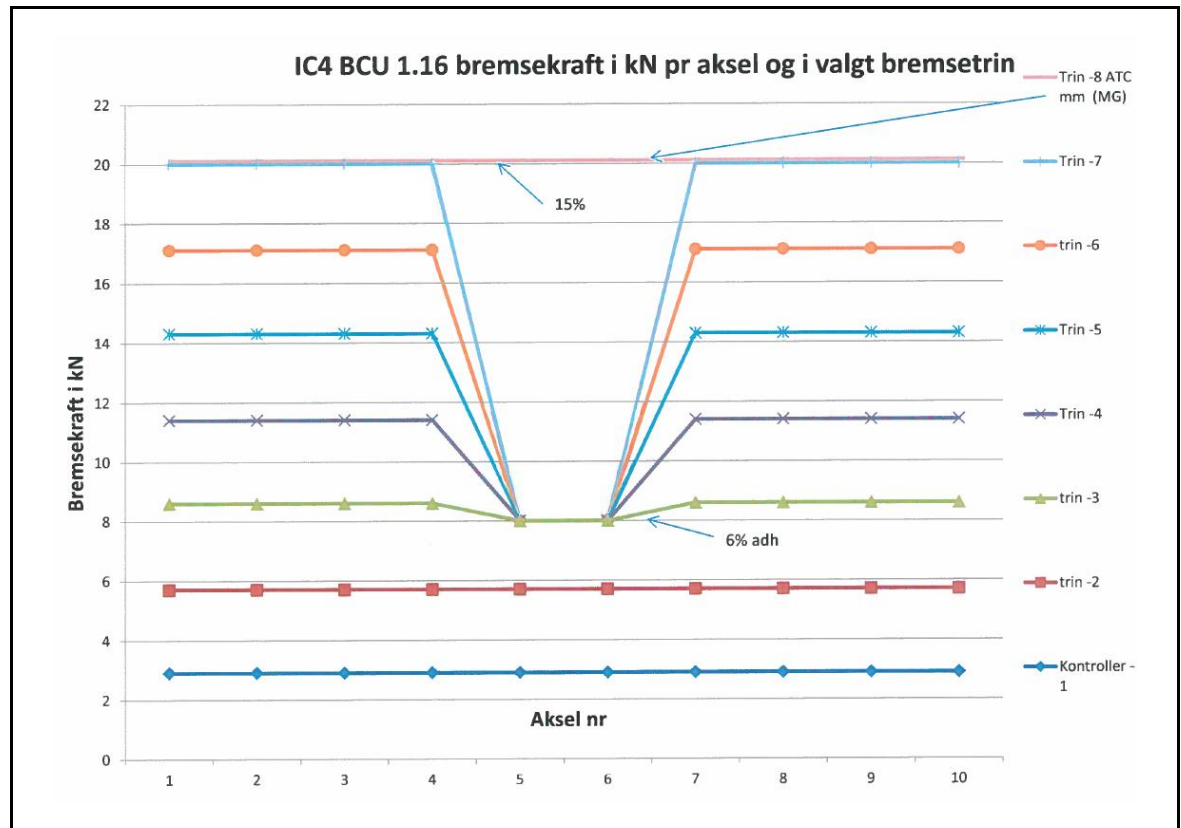

figure 10-3: Blending: repartition of the braking efforts (A2, 046)

Because the compensation of the HDB force by the EP brake was not always ensured the IC4PT brake task force team decided to simplify the blending philosophy as defined by CFG-DSB0274 (A2, 358). The cross blending function will be cancelled and the same brake force is evenly distributed to all axles of the trainset as shown in figure 10-4.

The new blending philosophy according CFG-DSB0274 is going to be implemented with a new BCU software version 1.16.



**figure 10-4:** The new blending philosophy defined by DSB with the same braking force on all axles (A2, 018)

For the service brake, the brake force increases regularly depending on the position of the brake lever. The brake force is equally distributed to the axles, with the exception that there is a reduction on the trailer axle 5 and 6 in order to hinder any locked wheel even with very low adhesion values, hence providing a reliable speed reference for the ATC. The brake force is the same for both trailer axles because they are supplied by the same BCU.

For the emergency brake the brake force are the same as for the full service brake but evenly distributed to all axles, even to the axles 5 and 6. Hence the 2 goals with the new version 1.16 of the BCU software are:

- Ensure same brake forces in full service brake mode (with or without HD) and in emergency brake mode
- Ensure evenly distribution of the brake force to all axles

### 10.2.2.5 Assessment findings new blending philosophy BCU SW 1.16

According to the on vehicle type test report provided by Faiveley Transport (FT) (A2, 401) and in order to have a first estimation of the brake force repartition (distribution) for the assessment of this report the brake forces were calculated from the measured cylinder pressure values and achieved HDB force values using the mechanical parameters from the former calculations (A2, 045/046). The distribution of the calculated brake force to the axles and the related required adhesion are given in figure 10-5.

It has to be pointed out that the calculated brake force values may differ from the real values. Therefore a detailed analyse should be done by the IC4PT brake task force team with the exact values.

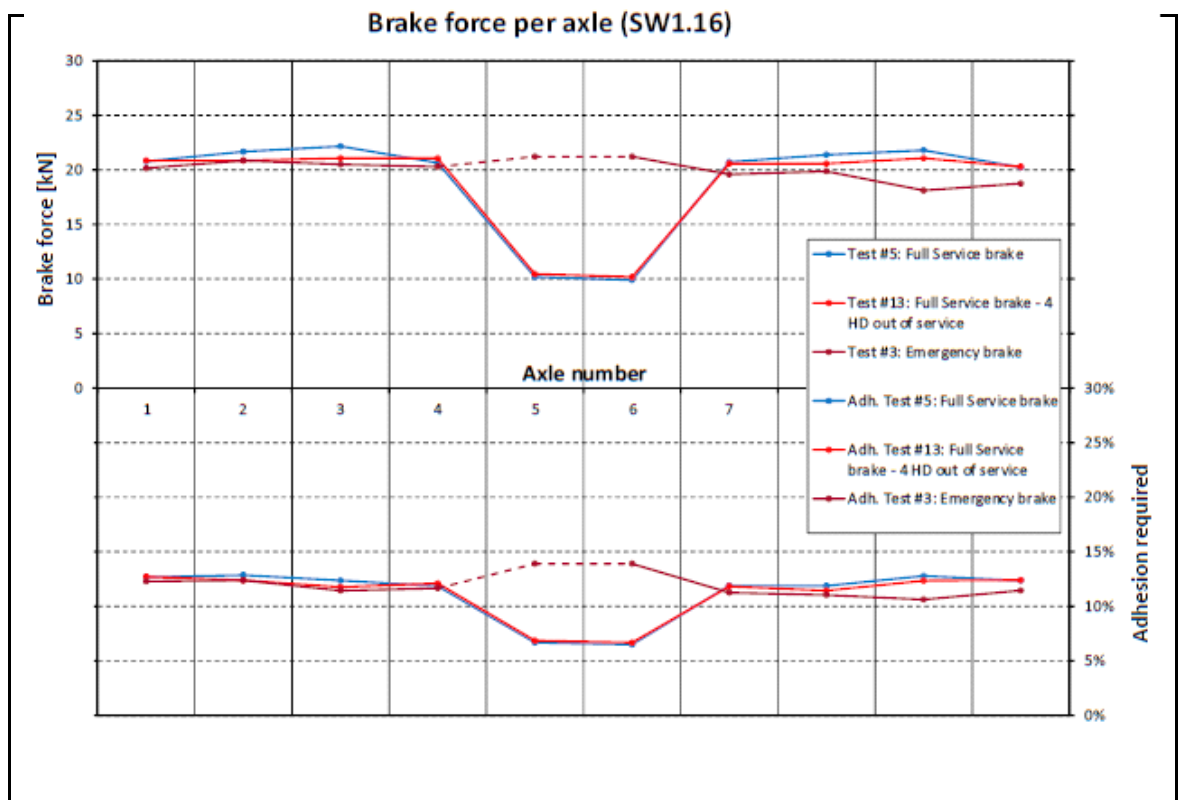

figure 10-5: The new blending philosophy according to FT values (A2, 401)

It can be noticed that the calculated brake force is not equally distributed between the axles as specified and required (figure 10-4):

- Full service brake mode with HDB: variation 9%, the motor axles have a higher brake force than the trailer axles 1, 4, 7 and 10 without consideration for the axles 5 and 6
- Emergency brake mode: variation 15 %, the axles 5 and 6 have a higher brake force
- Full service brake without HDB: the repartition is almost equal with a variation of 3%

Considering the required adhesion, the variation between the axles is about 8% for the full brake service with and without HDB and 28% for the emergency brake.

Since the values have been only calculated, no final assessment can be made.

Nevertheless, even if these variations don't have relevant consequences the question rises

why the brake forces are not evenly distributed to the axle as defined by IC4PT brake task force.

The calculated brake forces for the two BCU software versions according to the braking modes shows table 5.

	Brake force [kN]	
	BCU SW1.14 Calculation 01/2005	BCU SW1.16 Test specification
Full service brake with HD	201	196
Full service brake w/o HD	209	194
Emergency brake	225	208

**table 5:** Brake force according to brake mode (A2, 045/046/401)

The current version 1.14 of the BCU software shows:

- The brake force in emergency mode is 7% higher than the brake force of the full service brake with HDB
- The brake force in emergency mode is 12.5% higher than the brake force of the full service brake without HDB

These differences result in a different braking behaviour for the drivers depending on the brake mode used.

The new intended version 1.16 of the BCU software with the calculated brake forces shows:

- The brake force in service brake modes with or without the HDB are almost similar
- The brake force in the emergency brake mode is 7% higher than for the service brake without HDB

The comparison of both BCU SW versions shows that the brake force is 8% higher in emergency mode with the current BCU version 1.14. These results in that the braking percentage with the new intended BCU SW version 1.16 are lower.

The aim of the version 1.16 is to ensure the same brake force for the different brake modes. It can be concluded that this is not fully achieved. We therefore recommend a careful analyse of the real brake forces for the different braking modes in order to assess if the changes are acceptable or not.

Furthermore it has to be carefully analysed if the value of 170% is still achieved with regard to the braking distances which will be measured during the dynamic tests.

## 10.2.2.6 Assessment results and recommendations

### 10.2.2.6.1 Results

The task force implemented after the Marslev incident revealed two major failures in the system design that couldn't be easily detected during the dynamic type tests but should have been detected during the static type tests. The measures defined and implemented by the IC4PT brake task force seem adapted in order to get rid of the speed limitation. By today it is not possible to have a final assessment of these measures because the results of the tests performed for the validation of the WSP-system and the results of the dynamic tests with the new BCU software version 1.16 (CFG-DSB0274) are not known. Furthermore a comprehensive validation plan of the CFG-DSB0274 is missing for:

- Criteria for the validation of the on vehicle tests (A2, 401)
- New brake percentage and distances to be calculated
- Validation of the measured braking distance according to a new brake distance calculation (it is surprising that FT defines unilaterally the test specification and that the IC4PT brake task force doesn't have the lead for the definition of the tests requirements and all necessary validation criteria)
- No validation in regard to side effects of the new brake force distribution and changed braking torques are addressed:
  - Possible impact on the performance of the WSP-system
  - Thermal behaviour of the brake components
  - Resulting stresses to adjacent components (e.g. bogie components like axles, bogie frame structures)

### 10.2.2.6.2 Recommendation

The dynamic tests of the software version of the BCU 1.16 were performed by FT in October 2014. Unfortunately neither the test specification nor the test results according to the dynamic test program (A2, 382) could be provided during the assessment (A2, 390) due to incomplete document status by FT.

Further documents beside the FT dynamic tests especially in regard to the complete validation of the new BCU software version 1.16 and their side effects to adjacent components or subsystems could not be provided by IC4PT which limited this assessment task.

Since a complete analysis and validation of this complex CFG-DSB0274 is necessary before the implementation on the IC4 following measures and validation points are recommended strongly:

- As mentioned before, the brake percentage has to be calculated according to the measured brake distance in order to define the value that can be set in the ATC and the related maximal operating speed
- The report made by FT (A2, 401) and the dynamic tests performed need to be analysed:
  - As mentioned before the brake force is not equally distributed to all axles and the total brake force is 7% higher with the emergency brake mode. The criterions for the acceptable braking force per axle have to be defined in consideration with the possible influences to the components of the system.
  - The HDB force achieved is around 20% lower than the requested value, resulting in higher braking forces to be performed by the pneumatic brake. This difference is not fully explained by FT because this is not part of its scope and since the cylinder pressures are according to the nominal values the results could be satisfactory in the view of FT. Nevertheless in order to assess if these results are satisfactory for the reliable behaviour of the whole system a closer analyse of this point is strongly recommended
  - For the emergency brake mode the axle 5 was isolated during the test, this is not according to the test specification (A2, 305)
- No brake calculation has been provided by the suppliers of the brake system. The requirements for the assessment of the measured braking distance are normally defined from the calculation. The basis for the acceptance of the dynamic brake tests is therefore not clear.
- The side effects of the new brake force distribution have to be analysed and verified carefully by using measured values from the dynamic tests:
  - Influence and impacts to the performance of the WSP-system in order to ensure that the results of the tests performed for the validation of the WSP-system (See chapter 10.2.2.6.1) remain valid after the implementation of this new blending software release
  - The thermal behaviour of the wear components especially brake discs
  - The stresses resulting to the bogie components, especially the axles and bogie frame which have to be validated according to the measured braking torques

### **10.2.2.7 System reliability**

Beside the above mentioned issues no critical failure of the brake system occurred. Nevertheless some components (e.g. PSL, PFA and calliper switches) have a huge negative impact on the reliability and availability of the trainsets.

The following CFG's were opened:



#### **10.2.2.7.1 CFG-DSB0162: PSL switch on the brake pipe**

The pressure of the brake pipe is monitored by a dedicated pressure transducer and by a set of pressure switches. These pressure switches are used during the safety brake application control. One of these switches is dedicated for the detection of low pressure (PSL): this function allow to energise the EVSOCC valves when the pressure in the brake pipe is lower to 2.5 bar and remove this signal when the pressure in the brake pipe rise to 3.5 bar. There is one PSL switch per BCU providing a high redundancy level.

The CFG-DSB0162 was opened to improve the reliability of the switch (exchange of the switch).

#### **10.2.2.7.2 CFG-DSB0276: PFA switch for the cylinder pressure**

The cylinder pressure of each axle is monitored by the PFA switch placed after the WSP valve. The PFA value is ON if the cylinder pressure is higher than 0.5 bar (meaning the brake is not released). The value of the PFA is compared with the value provided by the BCU itself. If at least one PFA switch of a not isolated axle is ON the driver is informed about friction brake application in progress. In operation when the brake demand is released, there is an error if the holding brake is not released within 8 seconds during the start up. Nevertheless this control delay seems too short and will be increased to 15 seconds.

It has to be mentioned that the cylinder pressure is additionally checked by the pressure transducers TBC between the brake panel and the bogie hose. Each cylinder pressure is therefore monitored by three different components.

#### **10.2.2.7.3 Calliper switch**

One calliper switch is mounted on each calliper with parking brake in order to detect the status of the brake (Released or Applied) when the caliper brake is isolated.

Additionally each switch gives a further sure braking indication: it is activated when the calliper is moved from the idle position and start braking due to pressure inside the brake cylinders, despite of the brake mode: service (EP or IP) or parking.

Many failures occurred because the switch is not reliable: in operation the brake are wrongly detected applied and the trainset is stopped. With the version 2.1 of the TCMS, in case a closed caliper is detected the state of PFA switch and BCU will be additionally checked providing a reliable detection. Nevertheless this change may annihilate the need for the calliper switch since the first reason for the implementation of these switch is to give a sure not braking indication, even if the parking brake is isolated (A2, 038/047). Before proceeding to this modification, it has to be ensured that the side effects have been analyzed considering the whole safety level of the brake system.

#### **10.2.2.7.4 Results**

The reliability problems that occur because of the different switches (PSL, PFA and calliper switch) show that the brake system of the IC4/2 is complex with numerous monitoring equipment and redundancies. In deep tuning and verification will remain needed during the next months and we advise to strengthen the task force with the aim:

- To deepen the knowledge of the system and the components
- To analyse the side effects of each modification
- To identify the possibilities to increase the reliability of the system

## 10.2.3 Axle box housing

### 10.2.3.1 Overview

Cracks and fractures at the primary damper supports (figure 10-6) at the lower part of the axle box housing (herein after called “damper support”) is one of the main topics which has consumed a high amount of additional resources for inspection in the workshop. This prevents the achievement of the goals set by the deployment plan (A2, 015) primarily in respect to CFG implementation (MDBF performance).

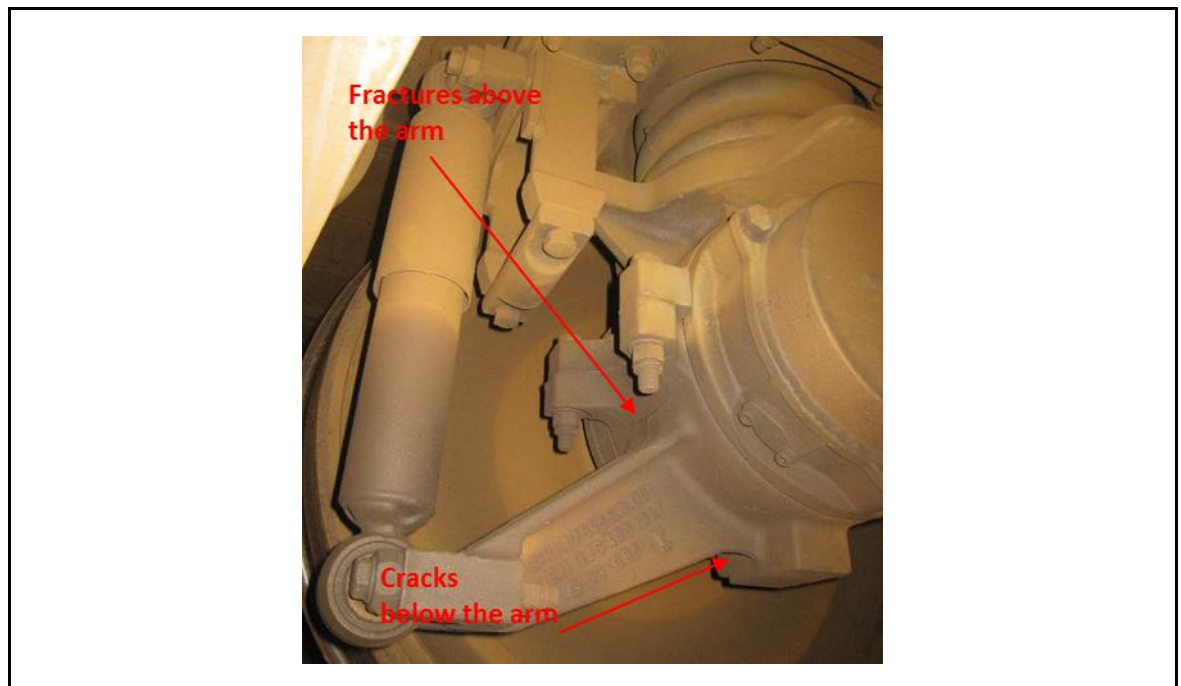

figure 10-6: Primary damper supports at the lower part of the axle box housing

### 10.2.3.2 History and present status

During February 2010 till end of October 2014 there has been detected 3 broken damper supports and 6 cracks at the damper supports, as reported in the list (A2, 340). This list contains also all the damaged primary dampers which have been found since March 2014. Before this time it has not been registered. In addition to this list a lot of dampers have been replaced due to sweating and leaking.

Since the observations as described in chapter 10.2.3.1 intermediate measures like work and maintenance instructions (A2, 150) were set up to keep the topic in the meantime under control.

Furthermore a lot of investigation, inspection (A2, 002/162-167) were launched and carried out by 3<sup>rd</sup> parties involved to understand the mechanism and identify the root causes. In addition measurements (A2, 121/202–205) have been defined and carried out for the RCA.

Since early October, week 40/2014 (A1, 23) the interval for inspection of wheel condition, damper support and primary damper has been enlarged from 7 days or 5,000 km to 30,000 km (A2, 119) approved by DSB-S (A1, 23).

### 10.2.3.3 Root cause analysis

The RCA done by IC4PT shows following results:

#### 1. Worst wheel conditions

- a) Bad wheel maintenance based on faulty maintenance instructions, checking and measurement wheels at 180,000 km intervals (A2, 002/130/206)
- b) Over breaking trailer especially leading axles due to BCU SW failures regarding wrong cross-blending in case of loss the retarder of the PP (A1, 23), details see chapter 10.2.2.3.2
- c) Failures in brake piping acc. CFG-DSB0022 (A2, 113) (see chapter 10.2.2.3.1)

#### 2. High reaction forces of the primary damper

- a) Outside of the normal operating range of the primary damper the characteristic is exceptional strong progressive (A2, 171)

Exceptional cases beyond normal operating modes for instance coming from collision of the wheels with objects or driving by worst wheel conditions will lead to high compression speeds for the damper.

Two different kind of weak points at the damper support were identified:

- A) 3 fractured damper supports in the area over the arm close to the casting edge (have been only on the leading trailer axles) see figure 10-7.  
1 crack at the damper support in the area over the arm (on a driven axle)
- B) 5 cracks at the damper supports in the area of the bottom part, at the reinforcement under the arm have, which is the most vulnerable place for fatigue cracks concerning the maximum permissible stress level as predicted by the FEM calculation (A2, 117) see figure 10-8.



**figure 10-7:** Fractured primary damper supports above the damper support arm



**figure 10-8:** Cracked primary damper supports under the damper support arm

Further RCA has been carried out to verify the dynamic input loads for the damper support. For this reasons AB were assigned carrying out measurements (A2, 121) in May 2014 based on test specification (A2, 202–205). In terms of compressions speed at the damper the highest exceptional single speed which has been found during AB measurements (A2, 121) was 1.7m/sec. However the conclusion is that all measured accelerations are in the range as expected (A2, 118) or at least below the assumptions taken by DB Systemtechnik (A2, 002).

To get an overall picture an identification of the associated mechanisms has been analysed in consideration of:

**Broken (cracks in) damper support <-> broken (cracks in) dampers <->**

**Brake forces <-> wheel conditions**

The findings in this context are:

- There could be assigned 7 or 8 damaged dampers in correlation to 36 wheel sets where wheels were re-profiled / turned more than 25 mm (A2, 127).  
There is a correlation between wheels in worse condition, cracks in damper support and broken dampers (A2, 340).
- Leading axles are exposed for collision with objects which creating additional exceptional single reacting forces from the dampers and also exceptional impacts from inertia of the mounted parts.  
There is a correlation between all (3) broken damper supports over the arm on the leading axles (A2, 340). (However 1 crack at the damper support over the arm on a driven axle could not be explained.)

#### 10.2.3.4 Measures defined by DSB

The proposed measures by IC4PT to solve this issue are following:

##### 1. Normal wheel conditions

- a) Improvement of the wheel maintenance according to a wheel manual which will shortly be installed (common for all trainsets at the DSB fleet) and a specific maintenance procedure already documented in SAP which requests a visual inspection latest within 30,000 km (A2, 370)

Besides this there has been also decided to carry out "comfort turnings" of the wheels at 80,000 km at front bogies and 120,000 km at intermediate bogies against (A2, 130)

- b) Monitoring wheel condition at track side installed WILD system (A2, 128) between Copenhagen and Aarhus at the belt bridge (more will be installed in the future)
- c) A new BCU SW (Version 1.16) according to CFG-DSB0274 will be provided which includes proposed corrections in blending amongst other things (details refer to chapter 10.2.2.4).
- d) Correction of failures in brake piping according to CFG-DSB0022 (A2, 113) which has been already finished on the last trainset in March 2014.
- e) An additional development proposal is the evaluation of changing the hardness of the wheel. The intention is to change the currently used wheel material R7 to "Superlos" (provided by supplier Lucchini in Italy), which reflects the upper part of the yield strength of R8 material.

##### 2. New primary damper

A new primary damper by Seneberg (A2, 176/177) is defined in CFG-DSB0281 (A2, 174) to provide one third of the reaction force at very high compression (A2, 171) against the existing one (A2, 169). This has a high priority but does not belong to the top ten of CFG.

Changes at the damper support of the axle box itself are not considered since the above mentioned measures should eliminate the negative effects of stressing the damper support.

### 10.2.3.5 Assessment Findings

#### 10.2.3.5.1 Root cause analysis

The dynamic input loads to the damper support have been verified as explained above in chapter 10.2.3.3 based on measured accelerations but didn't consider the measured strains at the different strain gauge (DMS) locations. Furthermore it has to be stated that there is concern in regard to the verification of the axle box design itself as per particulars given below:

1. The AB dynamic measurements on line tests in May 2014 did not evaluate the DMS at the seam, where the damage occurred for whatever reason. The maximum measured dynamic stresses at test on line under operational conditions shows approximately 34 MPa for a bad wheel and only 9 MPa for a wheel in good condition (A2, 121). The measured degraded wheel with out of roundness was 0.4 mm against 3.27 mm (worst wheel condition) which has been founded in former times during operation. Anyway these values for out-of-roundness of 0.4 mm are under the permissible strength value given by the last re-calculation of the sub-supplier FAG (A2, 117) who has the design responsibility.

2. The fatigue strength value used by FAG (A2, 117) is higher than the value according to the FKM- guideline (i.e. compression-tension endurance limit). Although a casting surface factor has been taken into account no safety factor value in terms of casting material and material safety factor generally has been considered. Unfortunately no raw-cast part drawings or information about inspection and cast factors are available.

That would mean that new evidence by FEM should be provided resulting in smaller security due to the reduced permissible strength value. In sum, the reflected safety does not correspond to FAG reports (A2, 117/163/164/165).

3. Furthermore the used "analytical surface" in FEM model (A2, 117) is too stiff for realistic FEM calculation. For instance, local deformation by inclination of the bearing housing is not covered which leads to more (unknown) pre-load of the screws causing in additional superimposed tensile stress. This could be critical for the fatigue strength and has not been considered in the calculation, too. In addition the stiffness of the bearing itself should be considered as well which also leads to more realistic results and is state of the art today.

Last but not least for a complete RCA geometrical interferences must be excluded as well. From design point of view unfortunately there is no possibility to identify the proper fit between the outer bearing ring and the lower axle box housing inner shell due to missing detailed information by the sub-supplier, as already stated by former investigation (A2, 002).

These described effects (local deformation by inclination of the bearing housing; consideration of bearing stiffness; geometrical interference) could lead to higher pre-



load of the screws. This would result into additional superimposed tensile stress and reduces thereby the possible utilization of this region.

Concluding also in this concern the evidence by FEM (A2, 117, 163, 164) is not provided for realistic design and boundary conditions where again evidence based on a corrected FEM is recommended strongly.

4. Compliance is given to the currently conclusion that the bottom part in the area of the reinforcement under the arm of the damper support (figure 10-8) is the critical place for fatigue cracks in regard to maximum permissible stress level as the FEM analysis predicts (A2, 117). This is assigned to the 5 founded cracks at the damper supports in this area (A2, 340).

A strong indication for the finding above mentioned under 3. is given by the fact that there has been found three (3) broken damper supports over the arm close to the casting edge (figure 10-7) on the leading axles and 1 crack at the damper at the same place (support over the arm) on a driven axle (A2, 340).

In general the FEA (A2, 117/163/164) provides no explanation for the existing failure at this location. Independent of any material properties there is always the highest utilisation in the area of the reinforcement below the arm. Therefore, there is either an additional force present or the boundary conditions are different. On one hand it could be generated by exceptional single loads (and then developed as fatigue cracks by running on worst wheels and worst dampers) as identified by the findings of IC4PT (chapter 10.2.3.3). On the other hand the received pictures (see random collected figure 10-9) from the lower axle box housing show marks like fretting corrosion which is an indication for geometrical interferences or local deformations caused by inclination of the bearing. Knowing that the investigation reports carried out by FAG itself or FORCE (A2, 162/166/167) give no explanation for the failure over the arm it is recommended to invalidate this assessment for this failure.



**figure 10-9:** Pictures of axle box lower parts with fretting corrosion marks

### 10.2.3.5.2 Measures recommended

The measures defined by the IC4PT (See chapter 10.2.3.4) will eliminate negative effects regarding dynamic stresses. Also measures to change the wheel material will help to stabilise wheel fatigue behaviour in regard to wheel fatigue. However it should be recommended to test it at a small number of trains in field tests to collect experience regarding wear of wheel and rails. Attention should be paid also to the behaviour during mounting (press on / press off).

Additional measures cannot be excluded as long as the RCA hasn't been finalised as recommended above. In case that the failure is caused by higher bolt forces in the lower axle box housing it has to be noted that the reaction forces of these bolts have an effect on the upper part of the axle box lever as well. Therefore, an investigation of the upper part of the axle box is advised. In general this is covered in case of a fatigue analysis of the complete axle box housing with the axle bearing (as state of the art).

It has been stated that initial cracks may cause by obstacles on the track. This has not been avoided by the rail guard since this element is design for worn wheels and not for new wheels refer to figure 10-10. To avoid future collision with larger objects this rail guard can be lowered in such a way that the wear of the wheels can be corrected by shimming or similar.

To ensure that the out-of-roundness of 0.4 mm is under control the wheel maintenance manual should follow EN15313 which allowed a maximum of 0.3 for this type of trainset.

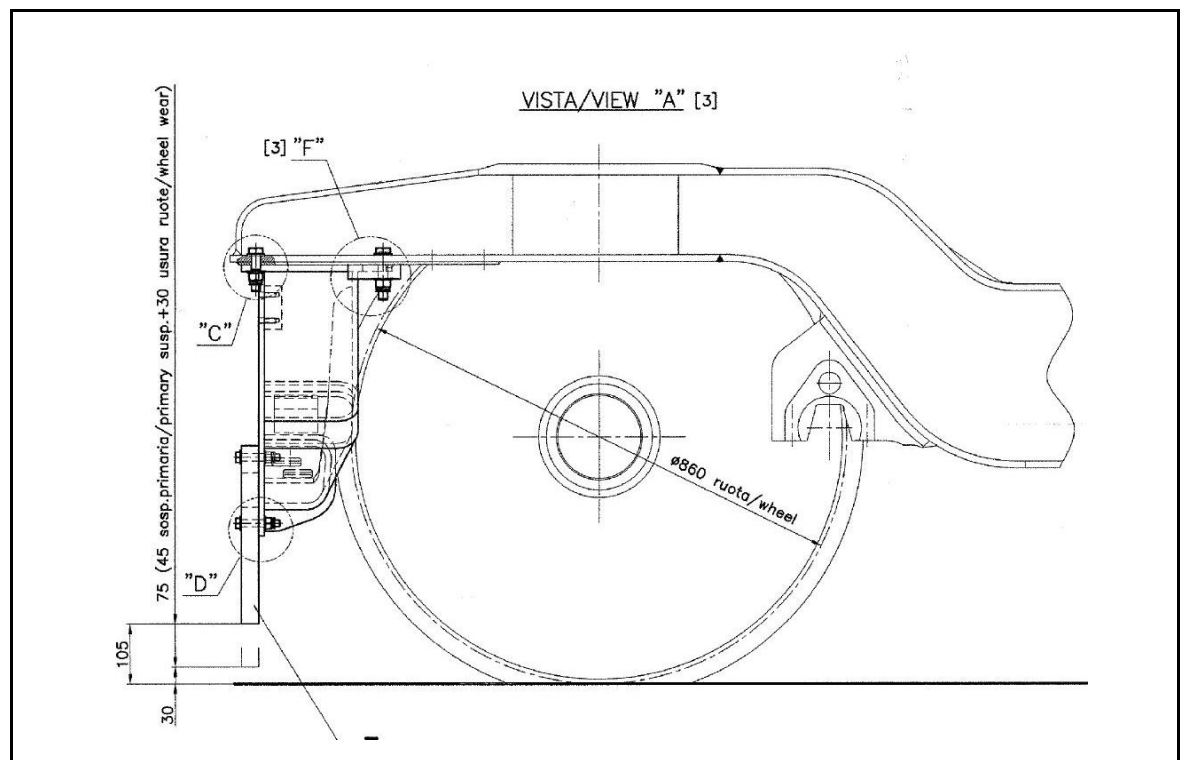

figure 10-10: Rail guard mounting (A2, 352)

### 10.2.3.5.3 Outlook, General risk disclosure

The damper support is at the lower axle box housing which has not high significance because its function is:

- Provide support for primary damper (influence on running stability of the trainset at high speed)
- Provide lift lock when the trainset, bogie will be lifted

However the upper part of the axle box housing which is guiding the trainset and carrying all the transmission loads has to be seen as high significant. As per chapter 10.2.3.5.3 an investigation of the upper part of the axle box is strongly recommended.

Additionally all stress analysis (A2, 163/164) by FAG has been performed acc. the loads defined in technical axle box specification document 1st edition 00, dated to 2001 (however the current revision 02 dated to 2002 is the valid one (A2, 207)). But the specified loads are lower and therefore not in agreement with the up to date wheel load measurements. For instance the wheel load measurements at trainset nb. 86-5615 in April 2014 (A2, 131) are in good accordance with the weight status document (A2, 115) from 2009 which reflect higher axle loads and therefore axle box reaction loads.

In summary the stress analysis (A2, 163/164) by FAG did not consider the actual higher weight balance (difference > 1 tons per axle) maybe due to lack of information between design phase based on load assumptions and type test phase with proofed (actual) loads. This results in that evidence by FEM (A2, 117/163/164) is not provided for realistic design mass. Having said this means that once more evidence based on a corrected FEM and update of load case document or specification itself (A2, 207) is strongly recommended.

In addition according to the original technical specification for the axle box of 2002 (A2, 207) it was required to test axle box regarding fatigue loads. However during the assessment it has been stated (A1, 23) that neither document has been found nor anyone was aware of such a fatigue test.

## 10.2.4 Power generation (Power Pack)

### 10.2.4.1 Introduction

An IC4 trainset is equipped with 4 power packs, an IC2 trainset with 2 power packs. The power packs are mounted underneath the car body, two per end coach (IC2 trainset only on one end coach). A power pack includes the diesel motor, the turbo charger, the alternator, the air compressor, the cooling system and partly the control and supervision of these systems. The alternator, the air compressor and the cooling system is powered by the diesel generator hydraulically. Each power pack powers one axle by mechanical transmission (A2, 007).

Many changes have been implemented or are in the design phase. On the 1 October 2014 25 CFG's have been defined on the power pack (A2, 180). Some of them are regarded as critical because of the influence on the reliability and availability of the trainsets. The focus of the assessment has been set on the critical CFGs.

### 10.2.4.2 Critical CFGs

#### 10.2.4.2.1 Broken bolts and cracks in the manifolds – CFG-DSB0131 and CFG-DSB0277

CFG-DSB0131 was opened in July 2012 because of broken bolts on the manifolds (A2, 254). The bolts are close to the turbo chargers on both sides of the motor.

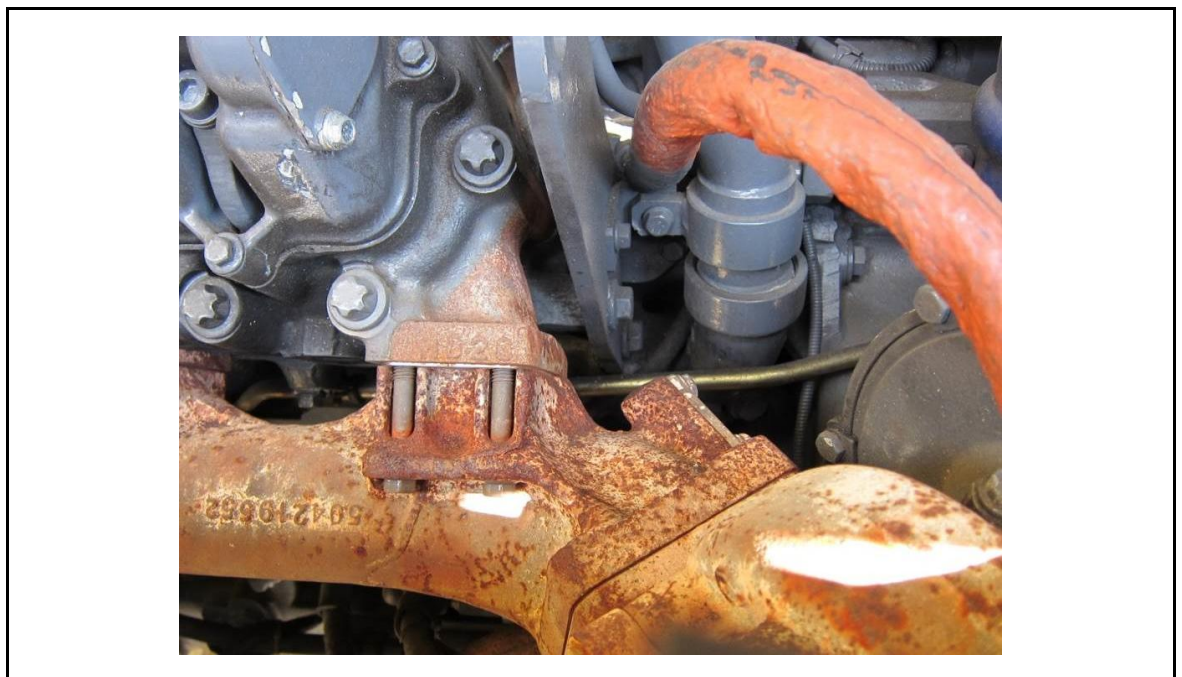

**figure 10-11:** Bolts for the mounting of the manifold close to the turbo charger (A2, 254)

The root cause has been quickly identified as being the weight of the turbo chargers that are eccentrically mounted, yet being only fixed by the manifolds. Due to the running dynamic loads on the turbo chargers, the manifolds and the bolts are highly stressed.

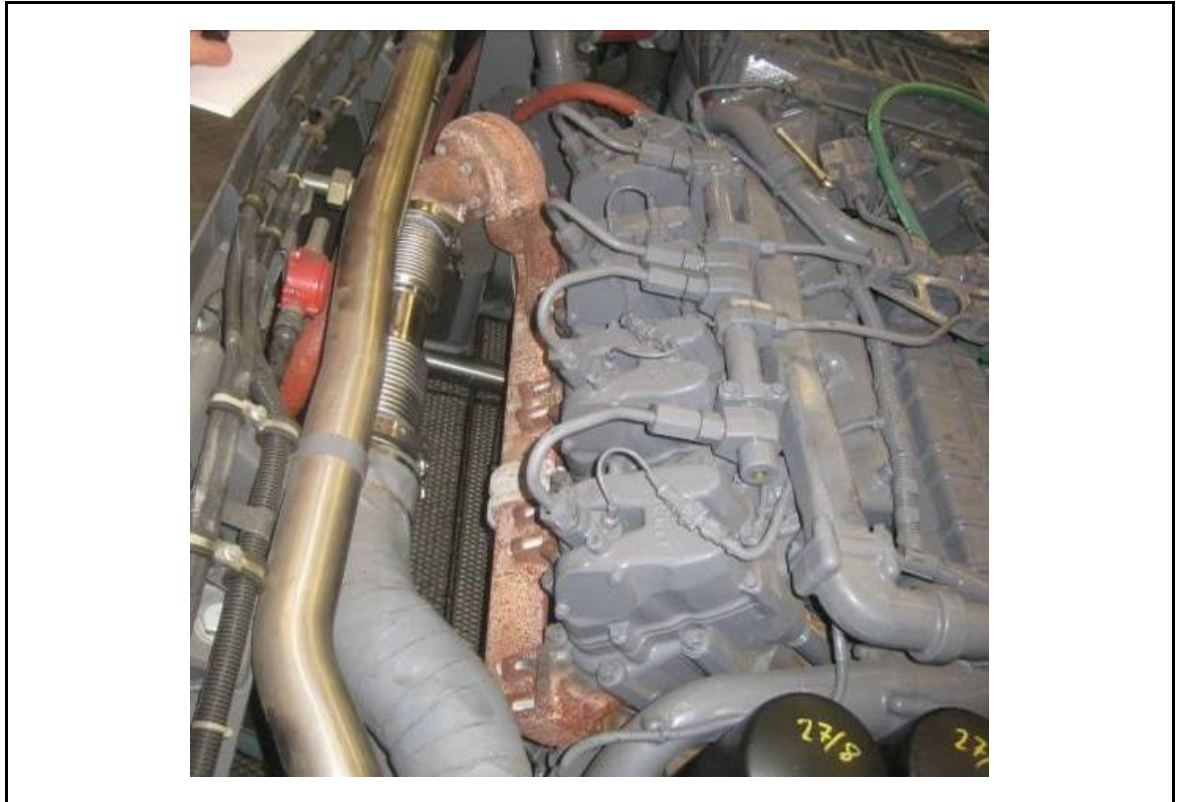

**figure 10-12:** Manifold and turbo charger mounted on the side of the engine (PROSE)

In June 2014 cracks have been found on the manifolds. The cracks are along a 45° line between the bolts and the turbo charger.



**figure 10-13:** Crack in the manifold between the turbocharger and the rear cylinder (PROSE)

As a palliative measure a regular visual check of the manifold was defined. 11 manifolds were found with cracks (A01, 25).

The CFG-DSB0277 was opened in August 2014. The root cause is a design failure where the dynamic loads of the application were not fully taken into account and a mechanical support of the turbo charges is missing. In case of a crack, the exhaust gas can escape in

the power pack area with significant heating effect on the surrounding components. The heating pressure can damage pipes, cables and components.

It has to be said that this is a typical defect seen on engine for the railway application, because the specific dynamic stress of rolling stock is easily underestimated by the engine suppliers. Solutions exist and it is assumed that the problem will be solved.

DSB already made IVECO aware of this problem and expects from IVECO to provide a design improvement that is compatible with the specificities of this power pack.

Nevertheless IVECO doesn't seem to take the responsibility. No solution has been provided yet and IVECO didn't deliver any action plan nor schedule to fix the problem.

DSB is also exchanging with railway operators and suppliers who experienced this problem. In parallel DSB developed internally a solution that seems adapted.



figure 10-14: Solution developed by DSB (PROSE)

The solution has to be tested in dynamic run considering that it's only after a high mileage (at least 200,000 km) that the effectiveness of the solution will be known.

#### 10.2.4.2.2 Investigation on fuel pipe broken

Leakages were found on 5 fuel pipes between the primary fuel pump (low pressure) and the secondary fuel pump (A2, 379/402). The pipe is  $\text{Ø}12 \times 1.5$ , fine grain steel E235 according to EN10305-4 (A2, 303). This pipe, provided by IVECO, is between two IVECO components and is directly mounted by IVECO on the engine. IVECO is therefore fully responsible for this component but is not actively involved for a solution, despite of DSB request.

The root cause of the problem is still not clearly defined. The leakage appears in the same area of the pipe, in a location with two tight bends close to the secondary pump. A first hypothesis is corrosion that appeared during the long time parking of the trainset. A second hypothesis is wear of the material because of cavitation effect. A third hypothesis is the bending process weakening the material.

When the engine is running the primary pump ensures the fuel supply inside the pipe. In case of a leakage there is no direct way to detect that fuel is lost. As leakage of fuel oil is

considered as a high risk, an inspection of the pipe concerned is performed every 7<sup>th</sup> day of operation (A2, 402).



**figure 10-15:** Area in the fuel pipe where the leakage appears (PROSE)

DSB performed a risk estimation considering the real frequency of the leakage with the result that the risk is undesirable (A2, 405). Therefore the risk estimation will be sent to DSB safety and mitigation actions have to be implemented.

DSB developed a first prototype of new fuel pipe based on the Aeroquip FC510 hose (FC510-08) (A2, 251/302). The hose is adapted to the application, withstanding fuel and lubrication with an operating temperature up to 150°C. The minimal acceptable bending radius of the pipe is 127mm, which is higher than the bending radius of the original pipe. Therefore an adapted connection has been designed by DSB.

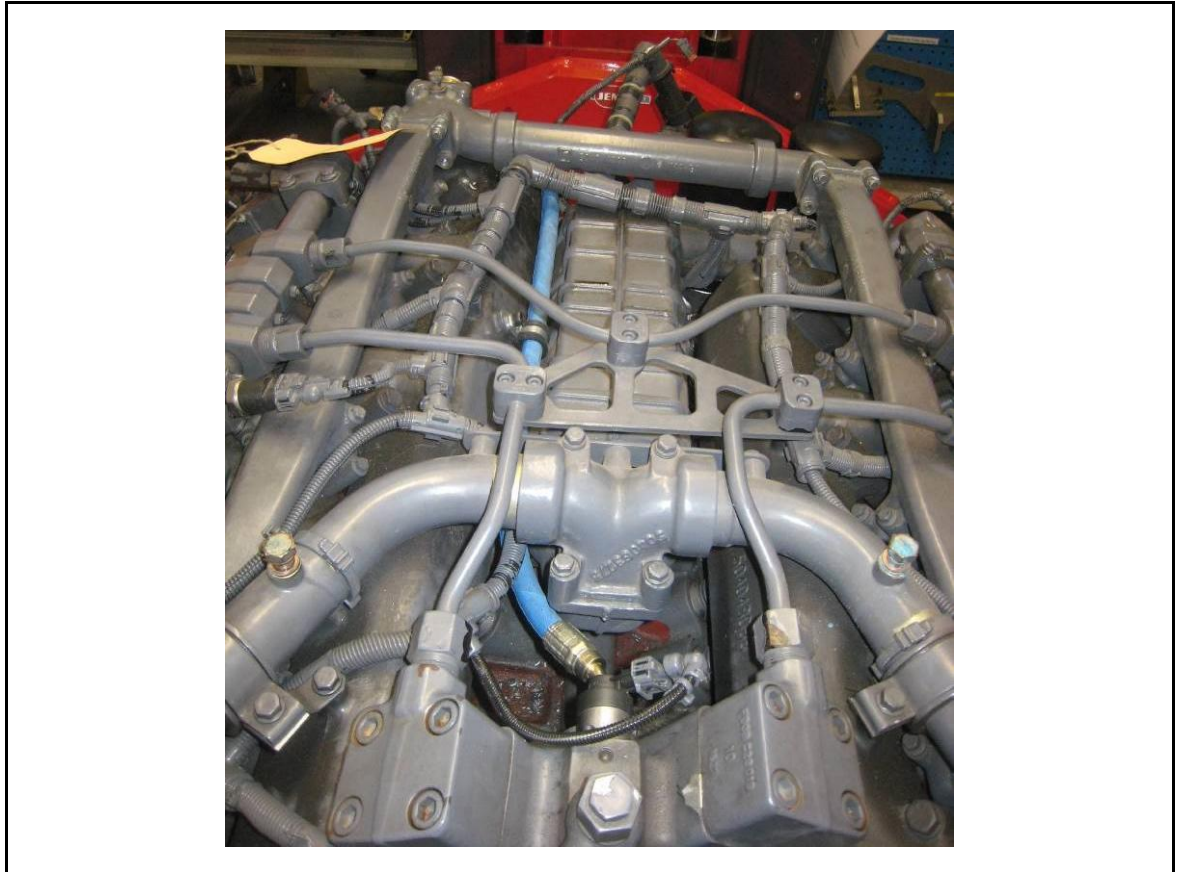

**figure 10-16:** Prototype based on FC510-08 hose from Aeroquip with the adapter for the connection to the high pressure pump (PROSE)

A second prototype is developed based on the GH100-8 ESP hose from Aeroquip (A2, 304). The hose withstands operating temperature up to 150°C and is adapted for fuel and application with new synthetic oil. The minimal acceptable bending radius is 51mm, which is of advantage compared with the FC510 hose.

The two prototypes seem to be able to provide a good solution for the problem. Yet they haven't been approved by FPT/IVECO and DSB is taking full responsibility for the solution. Nevertheless the issue is very sensitive with huge potential consequences in case of a fire in the engine area. Both solutions have therefore to be quickly tested in order to be able to replace the actual pipe. The behaviour in time and the reachable life time of the hoses will have to be investigated after the implementation on the engine through regular inspections during maintenance activities.



### 10.2.4.2.3 Thrust bearing of the crankshaft

In March 2013 a damaged crankshaft thrust bearing was found on the engine DM1379 (power pack 336A). Since then further breakdowns were found on four other engines with damaged thrust bearings and/or radial bearings, or even a damaged or broken crankshaft and hole in the engine block.

PP number	Engine number	Date	Km	Trainset number	Idle hours	Operation hours
PP 336A	DM 1379	07-03-2013	65.241	5642	652	911
PP 031B		22-05-2014	185.575	5630	2501	4183
PP 368A	DM 1249	27-01-2014	1239	5702		

**table 6:** Power packs and engines with damaged crankshaft thrust bearings

PP number	Engine number	Date	Km	Trainset number	Idle hours	Operation hours
PP 053A	DM 247	05-02-2014	161.048	5630	3956	2428
PP 095A	DM 529	03.03.2014	158.695	5648		

**table 7:** Power packs and engines with damaged/broken crankshaft and hole in the engine block

The damaged bearings are always found close to the main bearing Nr. 4 (A2, 385). The damaged thrust bearings are worn with deep grooves on the contact surfaces corresponding to the rotating movement of the crankshaft. The radial bearings have a damaged inner surface (spalling, grooves and eventually corrosion) (A2, 381). Because the engine DM1249 was mounted on an IC2 (5702) trainset the long time parking is not seen at first as the root cause.

An investigation of the problem is mandatory to answer the question if the root cause of all these breakdowns is specific to these 5 motors (specific operation or specific conditions like long time parking) or if the root cause is a failure in the design potentially impacting the whole fleet (lack of lubrication or too high loads). The former could be handled by the IC4 program with an accurate action plan. The latter may rapidly lead to high costs for the implementation of a design change and may become a major issue for the outcome of the IC4 program and the fulfillment of the deployment plan.

DSB started the technical investigation but it appears that the investigation is delayed because of the lack of available resources. The technical and financial risks connected to these breakdowns cannot be estimated today.

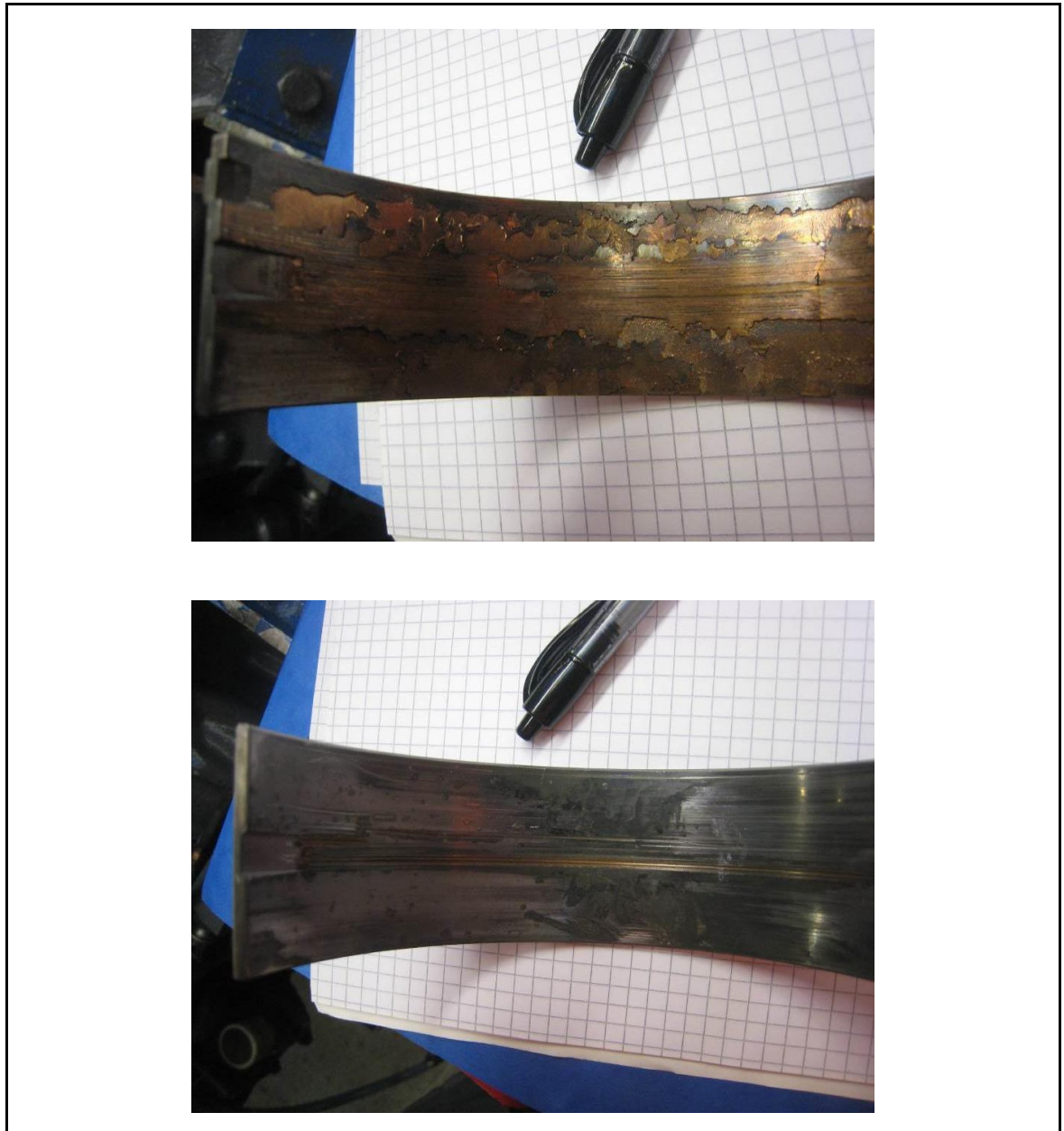

figure 10-17: Damaged radial thrust bearing: spalling, grooves and corrosion are visible (PROSE)

PROSE recommends the implementation of a task force to assess the risk of a design failure and to define the specific corrective actions.

#### 10.2.4.2.4 Cooling Alternator – CFG-DSB0262 / CFG-DSB0264

The a.c. alternator for providing the 3x400V/AC is powered by a hydraulic motor, which is connected to the diesel motor. The alternator is cooled by air that is taken in through a grid from the outside of the trainset. After cooling of the alternator, the air is blow out within the power pack. The electronic regulator of the alternator is placed in the air flow inlet (A2, 230). An IC 4 trainset is equipped with 3 alternators.

In the period between 1 January 2013 and the 29 May 2013 42 errors had been reported regarding the alternator (A2, 238).

One part of the investigations was to analyse the temperature in the area of the alternator and the cooling of the alternator and its control elements. Instead of an air flow of 22.4

$\text{m}^3/\text{min}$  as specified by the alternator manufacturer, only  $7 \text{ m}^3/\text{min}$  has been measured. This is only 30% of the value specified by the manufacturer (A2, 233).

To improve the airflow through the alternator, the air outlet has been enlarged by replacing the cover with a grid.



**figure 10-18:** Alternator with the new air outlet grid (left side) (Shown without side skirt) (A2, 180)

After the implementation of the new air outlet grid, an airflow of  $16.17 \text{ m}^3/\text{min}$  has been measured (A2, 141). This is still approx. 30% lower than the air flow specified by the alternator manufacturer (A2, 233). Additionally it hasn't been verified if the ambient temperature of the alternator is within the specification.

The impact of the temperature and the air flow to the electrical load has been addressed in the specification of the CFG (A2, 287). However, the power of the alternator hasn't been measured during the verification test. Therefore the comparison between a Power Pack without the modification and a Power Pack with the modification implemented like done in the tests report doesn't attest the improvement. Furthermore the modified solution hadn't been tested against a requirement, only if the new solution is better than the old one. Actually there is no verification reported, that the realised solution guarantees a sufficient cooling under operational conditions.

There is a significant risk that the measures defined are not sufficient, because:

- The air flow is still below the manufacturer requirement
- The ambient temperature of the alternator might be higher than the ambient temperature specified by the manufacturer
- The electrical load of the alternator during the record of the temperature values is not known

Recommendation:

- Investigation of the maximal electrical load in relation to the ambient temperature of the alternator and the airflow and temperature of the cooling.
- Verification of the measured value with the manufacturer requirements. Contact with the alternator manufacturer might be necessary to clarify possible deviations to the specification.

### **DC/DC Converter**

In terms of the faults of the alternator, the DC/DC converter has also been identified as a source of the faults (A2, 373). These DC/DC converters are used to provide status information about the alternator galvanically isolated (A2, 378).

The temperature of the DC/DC converter has also been measured during the alternator investigation in relation to temperature. Around the DC/DC converter, a temperature of 85°C has been measured, although some components are designed for a maximum ambient temperature of 60°C (A2, 238). The investigation if the DC/DC converter has an impact on the problems with the generator faults and if the temperature is the root cause, it is still ongoing (A1, 31). The aim is to analyse the impact of the vibration and the temperatures.

During the workshop visit we were told, that one of the solution considered is to position the DC/DC converter next to the electronic regulator of the alternator in the air inlet (A1, 31). Based on the measured value of the temperature on the electronic regulator, the mean temperature in the air inlet is around 45°C, but can exceed the 60°C threshold (A2, 289). This is around the maximum ambient temperature allowed for the relays. Therefore it is recommended to find a different solution or to investigate in a more detailed method the air flow and the temperature gradient in the air inlet.

Recommendation:

- Thorough analysis of the air flow and the temperature gradient in the air inlet to ensure that the DC/DC card can be placed there or to evaluate a different position
- A proper verification and validation shall be carried out, before the implementation on the fleet to ensure that the root cause has been found and the solution solves the problem.

#### **10.2.4.3 Changes due to incomplete engineering of the power pack**

DSB improved the performance of the power pack through various changes that revealed an incomplete engineering. Precise adaptations and optimisation are always part of the design of a complex system. Nevertheless the majority of the failures corrected during the first years of operation of the IC4 fleet should have been detected during the type tests and their solution implemented before the commissioning of the trainset. As a result the reliability and availability of the trains remained poor while the maintenance and engineering resources are occupied and not able to fix these problems in parallel to the daily support for the operation of the trainset. Nevertheless these changes are not seen as critical for the fulfilment of the deployment plan.

Below is a quick overview:

- CFG-DSB0032: mechanical protections of the power pack area were added in order to prevent the intrusion of pollution (i.e. autumn leaves). This modification is implemented with successful results.
- CFG-DSB0056: depending of the mounting tolerances and because of the dynamic movements a mechanical contact occurred between the power pack frame (suspended) and the carbody. The carbody was locally adapted in order to ensure a minimal clearance and avoid the transmission of solid vibration from the power pack to the carbody.
- CFG-DSB0065 and CFG-DSB0149: The limiting pressure valve of the air compressor has been successfully modified in two steps in order to increase the reliability of the air pressure production.
- CFG-DSB0091: Modification of the bracket of a brake pipe mounted underframe in order to prevent mechanical interference with the power pack.
- CFG-DSB0092: The hydraulic motor of the generator is mounted suspended on rubber elements to the power pack frame while the generator is rigidly mounted. Because of the ageing and creep of the rubber elements the misalignment of the two components exceeds the acceptable limits ( $\pm 1$ mm) with the result that the coupling between the motor and the generator is destroyed. The modification consists of the removing of the rubber elements and a shimming of the hydraulic motor in order to ensure a maximal misalignment of  $\pm 0.5$ mm.
- CFG-DSB0099: The thermostat for the valve of the passenger heating system was placed in an overly heated environment and was therefore not working properly. The thermostat was moved outside the power pack area which provided reliable functioning.
- CFG-DSB0119: In case of change of direction the axle reversing gear (ARG) supplied by ZF failed sometimes to engage due to tooth-to-tooth interference with the result that no traction was available. A solution to this problem was already available from ZF and implemented on the IC3 (it appears that AB didn't consider it useful to implement it). The solution was successfully implemented on the IC4 fleet.
- CFG-DSB0128: The exhaust pipe is fixed to the power pack frame by a rubber element which couldn't withstand the heated environment. The rubber element was successfully replaced by a metal suspension support.
- CFG-DSB0132: The air inlet hose showed weaknesses for withstanding the sucking depression together with the vibration. A new component has been defined with a more rigid material and successfully tested regarding the vibration. Yet the validation of the material in terms of the heated environment of the power pack is missing. We recommend investigating this aspect as a consequences as heat has already been the main issue for several CFG's.

- CFG-DSB0151: The gasket of the oil pump was replaced for a better withstanding of the heated environment
- CFG-DSB0180: The sealing of the inverter was improved. The remaining problem is that a cooling of the inverter is missing and the components inside the inverter are getting too hot. The investigation of this new problem is in progress.
- CFG-DSB0187: Leakage of the exhaust gas occurred because the mounting of the original clamps was unsteady and unreliable. The clamps of the exhaust line were changed and the maintenance instruction was improved.
- CFG-DSB0189: The starting process of the diesel engine requires the relay 5K25 to be closed. The relay 5K25 is active in case different safety related system work proper and the axle reverse gear is in neutral position (Only this information is relevant for starting the engine). Therefore it's currently not possible to start up the engine if e.g. the trainset has an ATC fault, which is irrelevant for starting up the engine. Due to this the battery could be empty until the problem is fixed and then the battery voltage is too low to start up the engine. The modification consists of obtaining a validation of the neutral position of the axle reverse gear through the TCMS instead of the relay 5K25 resulting in a starting procedure that ensure the same level of safety.
- CFG-DSB0230: In order to reduce the noise in the passenger section of the IC4 trainsets, an insert is installed in the exhaust system which separates the exhaust gases from the two power packs. Gas turbulence is avoided and according to the tests performed (A2, 271) the improvement of noise emission is validated. Nevertheless the modification modifies the flue of the gases and increases the backpressure in the exhaust system by 15%. After investigating the possible consequences of the increased backpressure, DSB decided to proceed to a modification of the exhaust muffler with the aim of reducing the back pressure inside the acceptable limit (see CFG-DSB0272).
- CFG-DSB0245: Wrong speed signal were provided by the anti-sliding system because of poor workmanship on the sonic wheel. The sonic wheels were inspected on the whole fleet and replaced where needed.
- CFG-DSB0246: The wheel diameter is a fixed parameter in the IVECO-SW for the anti-sliding system. The parameter was fixed to 860mm. Because the real diameter of the wheel can be between 800 and 860mm the system could detect an incorrect sliding with worn wheels, because wheels had a lower speed yet without sliding. The parameter was changed to the average value 835mm ensuring a speed deviation inside the tolerances of the anti-sliding system for every wheel diameters.
- CFG-DSB0247: It has been discovered that on some of the ZF mechanical gears the shift parameters "correction factor" used for the calculation of the gearbox input-shaft speed is switched off, resulting in a gear shifting that is uneven on the whole fleet. Further to this CFG, DSB plans to optimise the shift behaviour of the gear box in

order to improve the availability of the engine power in some portion of the network. DSB evaluates the cooperation with ZF as constructive.

- CFG-DSB0272: The exhaust muffler is optimised for the reduction of the back pressure (see CFG-DSB0230) and the reduction of noise. Tests are now in progress and the solution should be validated by the end of the year.
- CFG-DSB0285: The fixation of a brake pipe mounted underframe above the ZF gearbox is getting loose. The aim of this CFG is to improve the fixation and also protect the cables for the command of the gear box that can be damaged in case of mechanical contact with the brake pipe. The changes are addressing the root cause of the problem with adapted solutions regarding the heated environment and the vibration. It has to be properly validated and quickly implemented.
- RIT032: The main hydraulic pump is mounted suspended to the power pack frame with a rubber element. Because of the heated environment and the creep of the rubber, the misalignment of the pump and the motor exceeds the acceptable tolerances and the rubber coupling is damaged (problem similar to CFG-DSB0092). The problem is actually managed by the maintenance through curative actions: shims are added in order to compensate for the creep and deformation of the rubber elements. The definitive solution is not trivial because the deflexions of both the motor suspension and the pump suspension have to be compensated for. No CFG has been issued yet.



**figure 10-19:** Damaged rubber element for the fixation of the main hydraulic pump (PROSE)

The RIT is currently involved in other improvements that are not seen as critical for the fulfilment of the deployment plan.

#### 10.2.4.4 Findings and recommendations

Out of the 25 listed CFGs and current problems it appears that

- 16 of them (64%) are because the engineering of the power pack is not complete, i.e. the engineering of the system is not under control. The definition and implementation of these CFGs are very time consuming yet the improved reliability remains below the expected level because these issues shouldn't be experienced during operation. Some of these issues reveal deficiencies in the engineering (as for example CFG-DSB0056, CFG-DSB0092, CFG-DSB0126 or more recently CFG-DSB0285) promoting questioning in the layout of the complete system. It is therefore strongly recommended to investigate in details the design of the power pack with the aim of detecting failures before they occur in operation.
- Five of them (20%) are addressing issues that typically occur during operation, i.e. issues that cannot be easily detected during tests (CFG-DSB0065, CFG-DSB0132, CFG-DSB0187, CFG-DSB0189 or CFG-DSB0247). It means that roughly 25% of the resources of the RIT and engineering are effectively doing what they should. It has to be highlighted that for each of these CFG's the root cause analysis, the requirements, the verification and testing and the validation have to be done accurately in order to experienced steady improvement in reliability.
- 4 of them are critical (CFG-DSB0277, leakage in the fuel pipe, damaged thrust bearing of the crankshaft, cooling of the alternator). All of them require an accurate action plan for the investigation and the definition of the corrective actions. Risks are to be assessed in order to evaluate the possible consequences for the IC4 program.

Recommendations:

- A detailed technical assessment of the power pack is recommended. The power pack went through a comprehensive test program (A2, 242). Nevertheless the reliability and availability problems that occurred during the operation show not only that the power pack was not fully tested when entering in operation but also that important aspects of the design have not been handled properly. For the safe development of the program it is mandatory to strengthen the technical basis of the power pack by detecting possible failures before they appear during operation.
- Because some of the actual issues can have drastic consequences it is recommended that a task force is set up that will be able to investigate and implement solutions for the critical problems within a short timeframe. RIT and engineering will then be able to focus on reliability improvement.
- Some of the errors occur only after running certain mileages. It is recommended to that designated trainsets are prioritised for use in long distance traffic. Therefore five trainsets on the up-to-date configuration shall be designated to run a high mileage in a short period of time.



### 10.2.5 Possible consequences

The current solution on the power pack and the axle box housing is indicating weaknesses this could lead to major design changes:

- Design change leads to new engine, costing about 500,000 DKK per engine, 2 Mio DKK per trainset
- Design change leads to engine retrofit activities, costing about 200,000 DKK per engine, 800,000 DKK per trainset
- Design change leads to new axle box housings, costing about 40,000 DKK per bogie, 200,000 DKK per trainset

The costing is assumed based on experience.

## 11 Differences in conclusion to the Atkins report

This chapter give an overview of the differences in relative to the conclusions drawn up in the Atkins report of September 2011 (A2, 001) which has been determined.

Today is a completely different situation compared to October 2011, where the Atkins report was elaborated. The last trainsets were completed by end of year 2013. Now the trainsets are in operation collecting more mileages and operational experience.

Refer to chapter 6.2.1 the complete organisation has been changed. Refer to the chapter 4.3 of the Atkins report today the IC4PT is part of the DSB-M.

In chapter 3.2.3 of the Atkins report an actual ratio in 2011 of 50/50 between SPM and UCM is stated regarding maintenance resources. In reference to chapter 8 advice to adjust the ration to 10/90 is given. The current situation with 15/85 ratio is not the same as stated in the Atkins report. In addition a ratio of 90/10 as stated in the Atkins report is not realistic. Indeed the workshop performance has not been assessed by Atkins.

In chapter 5.4.2 of the Atkins report a reliability improvement is predicted. The statement is based on a calculated starting point considering a learning curve. Additionally an assumption of putting a RIT in place has been taken into account. As the RIT has been in operation since mid-2013 and some of the root causes are still unknown there might be a smaller adjustment in time referring to chapter 9.2. However the model stated by Atkins is still valid.

In chapter 3.1.1 of the Atkins report it is concluded that the major systems and major items of equipment fitted to IC4 trainsets are sound and are currently operating reliably.

Unfortunately now this is not the case as identified during the technical risk assessment (Chapter 10):

- Brake system
  - On 7 November 2011 the Marslev Brake incidence arose. During the investigation the two problems found by the task force (wrong piping of the parking brake and unequal repartition of the brake force on the axles) were not mentioned
- Axle box housings
  - No problems have been mentioned although two fractures already existed (February and December 2010)
- Power pack
  - 68% of the known CGF's are because the engineering of the power pack is not complete, i.e. the engineering of the system is not under control.

## 12 Abbreviations, Terminology

AA	Authority Approval
AB	Ansaldo Breda (Italy and Danmark)
a.c.	Alternating Current
ATC	Automatic Train Control
ARG	Axle Reversing Gear
BCU	Brake Control Unit
CFG	Rebuild and Campaigns to the IC4 and IC2 fleet
DMU	Diesel Multiple Unit
DSB	DSB Danske Statsbaner (Danish State Railways)
DSB-M	DSB Maintenance (DSB Vedligehold A/S)
DSB-O	DSB Operation
DSB-S	DSB Sikkerhed (DSB Safety)
DTO	DSB train reliability monitoring system
EMU	Electric Multiple Unit
FAG	Friedrich Fischer public company (of INA-Holding Schaeffler limited partnership)
FMEA	Failure Mode and Effects Analysis
FT	Faiveley Transportation
FTE	Full-Time Equivalent
HDB	Hydrodynamic Brake
IC2	2-car Inter-City diesel-mechanical multiple unit train designed and manufactured by AB
IC3	3-car Inter-City diesel-mechanical multiple unit train designed by DSB and ABB Scandia (now Bombardier Transportation), manufactured by ABB Scandia, and introduced to traffic in 1991
IC4	4-car Inter-City diesel-mechanical multiple unit train designed and manufactured by AB
IC4PT	IC4 Program Team
IDU	Integrated Diagnostic Unit (Human-machine interface in each driving cab)
KAC	Kastrup Airport Copenhagen
KPI	Key Performance Indicator
MDBF	Mean Distance Between Failure causing a delay > 5min
Mu4	TCMS software version
PP	Power Pack
QMS	Quality Management System
RAMS	Reliability, Availability, Maintainability and Safety
RCA	Root cause analysis
RIT	Reliability Improvement Team
SAP	Systemanalyse und Programmentwicklung (supplier of spare parts management software)
SBB	Swiss Federal Railways
SFDD	Subsystem Functional and Design Description
SPM	Scheduled Preventive Maintenance
TC	Train Computer
TCMS	Train Computer and Monitoring System
TRS	Tecnologie nelle Reti e nei Sistemi (sub supplier of AB)
TS	Trafikstyrelsen (National Safety Authority), Danmark
UCM	Unscheduled Corrective Maintenance
WSP	Wheels Slide Protection

### 13 Appendices

<b>ID</b>	<b>Content</b>	<b>Nb. pages</b>
A1	Journal: Meetings, Interview, Visits	4
A2	Document Reference List	6
A3	ISO 9001:2008	-
A4	OHSAS 18001:2007	-
A5	ISO 14001:2004	-
A6	EN 50126:1999	-
A7	EN 50128:2011	-

Project-ID :	14.104.00
Project:	Expert Assessment of IC4/2
Status:	05.11.2014

\*Note: Jesper Bruun Johansen, DSB Assessment leader, took part to each meeting.

Nb.	Date	Person(s)*	Departement / Organisation	Title	Subject and purpose	Location
1	26.08.2014	Ove Dahl Kristensen	IC4 PT Management	Expert	IC4 History IC4 deployment plan	Høje Tåstrup
2	26.08.2014	Lars Wrist-Elkjaer	IC4 PT Management	COO	IC4 status overview fleet, operation, MDBF, CFG, technical problems	Høje Tåstrup
4	26.08.2014	Torben Kronstam	IC4 PT Management	Senior Vice President DSB IC4 Program Manager	IC4 History, contract, TCMS, technical problems	Høje Tåstrup
5	26.08.2014	Søren Juhl	IC4 PT Engineering	IC4 R&D Manager	IC4 organisation, maintenance, MDBF, technical problems, Procedures RootCauseAnalysis	Høje Tåstrup
6	27.08.2014	Steffen Knudsen	IC4 PT Quality	IC4 Quality Manager	IC4 quality management history, CFG Proces	Høje Tåstrup
7	27.08.2014	Lars Slott		IC4 Technical Program Manager 2009-2013	IC4 quality management, homologation issues	Høje Tåstrup
8	27.08.2014	Ole Nielsen Niels Peter Naestrup Soerensen	IC4 PT Engineering	IC4 TCMS Engineers	IC4 TCMS history, TCMS packages old & new, TCMS-System overview, TCMS-Tests, Function problems multiple coupling	Høje Tåstrup
9	27.08.2014	Ole Mårtensen	IC4 PT Engineering	IC4 Brake Engineer	IC4 brake history, technical information, technical problems: performance, magnetic track brake, blending, WSP	Høje Tåstrup
10	27.08.2014	Peter Buchwald	DSB Maintenance	Chefkonsultant IC4 Task Force	IC4 components affected by errors: axel bearing, wheels, brake blending philosophy and analysis / solutions	Høje Tåstrup
11	27.08.2014	Kenneth Juul Alan ...	Spare parts		IC4 Organisation / procedures of spare part handling Obsolescence management	Høje Tåstrup
12	28.08.2014	Flemming V Jensen Thomas ...	DSB Maintenance DSB Maintenance	Workshop Manager Aarhus IC4 Production Manager	Inspection tour IC2/4 train set and maintenance facility, IC4 Status, Operation profile/status fleet, Maintenance work organisation, Status modification (CFG's), Error detection and correction; MDBF	Århus, Sonnesgade
13	28.08.2014	Niels Nielsen Stehen L. Andersen	IC4 PT Engineering DSB Maintenance	IC4 Project leader Workshop Coordinator	IC4 Management failures, CFG, DTO, HW-System/components affected by errors: 24V DC installations, Battery Charger	Århus, Sonnesgade
14	29.08.2014	Søren Børsting Thomas Bengt Jensen Flemming Bach Thomassen	DSB Maintenance IC4 PT Engineering IC4 PT Engineering	Planner MDBF team R&D Support Daily workshop issues	IC4 Reason analysis workshop, process, RIT, System/components affected by errors: brakes, door&steps, axelbearing, battery charger, wheels, traction /power pack, data collection	Århus, Sonnesgade
15	29.08.2014	Søren Østergaard	DSB Maintenance	Testmanager	IC4 history static / dynamic tests & commissioning	Århus, Sonnesgade
16	29.08.2014	Flemming V Jensen Jesper Bruun Johansen	DSB Maintenance IC4PT	Workshop Manager Aarhus Risk Manager / Assessment leader	Follow up meeting	Århus, Sonnesgade

Project-ID :	14.104.00
Project:	Expert Assessment of IC4/2
Status:	05.11.2014

\*Note: Jesper Bruun Johansen, DSB Assessment leader, took part to each meeting.

Nb.	Date	Person(s)*	Departement / Organisation	Title	Subject and purpose	Location
17	08.09.2014	Flemming V. Jensen Søren Børsting Niels Nielsen Søren Juhl	DSB Maintenance DSB Maintenance IC4 PT Engineering IC4 PT Engineering	Workshop Manager Aarhus Planner MDBF team IC4 Project leader R&D Manager	Participation to RIT weekly meeting discussions about actual / current problems, Decision-making, Priorities and base lines	Høje Tåstrup
18	08.09.2014	Torben Kronstam Søren Juhl	IC4 PT Management IC4 PT Engineering	IC4 Program Manager IC4 R&D Manager	Project Management, Financial schedule (short- and long-term) and figures for IC4 Program team, deployment plan	Høje Tåstrup
19	08.09.2014	Ove Dahl Kristensen Jesper Bruun Johansen	IC4 PT Management IC4 PT Engineering	Expert Risk Manager / Assessment leader	Discussion draft progress Report Phase 1, focused area's to be assessed	Høje Tåstrup
20	09.09.2014	Per Hein Ahmed Lutfi Øzer Janie Behrendorf	DSB Safety	Safety specialist	Organisation, Interface to IC4PT, maintenance and operation departments, Assessors, National authority (Trafikstyrelsen), Schedule, Process flow CFG's/modifications	Høje Tåstrup
21	09.09.2014	Peter Schmidt	DSB Finance	Economist	IC4 Economy agreed financially for preventive, corrective maintenance, modifications till 2019, Budget for IC4 Program (Engineering)	Høje Tåstrup
22	09.09.2014	Thomas Edelman Hans Sørup Jakobsen	DSB Operation		Opinion about IC4 vehicle/fleet, actual progress and development; KPIs agreed and measured (IC4, IC3 and IC2) Operation & Maintenance, Priorities / baseline schedule change Dec 2014 focus IC4, Collaboration, Interaction, Communication within DSB Maintenance	Høje Tåstrup
23	30.09.2014	Flemming Bach Thomassen Peter Buchwaldt	DSB Maintenance DSB Maintenance	Projektleiter IC4 Chefkonsultant IC4 Task Force	Axle Box: RCA, Measurements, Solution Structure, Load assumptions, Validation	Høje Tåstrup
24	30.09.2014	Ole Mårtensen Finn Jensen	IC4 PT Engineering IC4 PT Engineering	IC4 Brake Engineer Chefkonsultant Systemintegrator	Technical basic documentation basis known/available: Weight balance, Structure analysis, Typetests	Høje Tåstrup
25	01.10.2014	Niels Nielson Søren Poulsen	IC4 PT Engineering	IC4 Project leader	Overview of the Power Pack from engineering point of view	Høje Tåstrup
26	01.10.2014	Ole Mårtensen Peter Buchwaldt	IC4 PT Engineering DSB Maintenance	IC4 Brake Engineer Chefkonsultant IC4 Task Force	Brakes – Specific current CFG's and modifications as well as actions	Høje Tåstrup
27	02.10.2014	Lars Kragh Nykjær Michael Obeliv	Engineering Maintenance	Team manager Design Engineer Team leader ICMS Transfer	Overview of the automatic coupler from engineering point of view	Høje Tåstrup
28	08.10.2014	Søren Børsting	DSB Maintenance	Planner MDBF team	Overview of the automatic coupler from RIT point of view	Århus, Sonnesgade

Project-ID :	14.104.00
Project:	Expert Assessment of IC4/2
Status:	05.11.2014

\*Note: Jesper Bruun Johansen, DSB Assessment leader, took part to each meeting.

Nb.	Date	Person(s)*	Departement / Organisation	Title	Subject and purpose	Location
29	09.10.2014	Søren Østergaard	DSB Maintenance	Testmanager	Assisting of a coupling test Presentation of the improved coupler	Århus, Augustenborggade
30	09.10.2014	Thomas Kruger Bergstrand	DSB Maintenance	Site Survey Sonnesgade	Workshop inspection	Århus, Sonnesgade
31	09.10.2014	Søren Børsting	DSB Maintenance	Planner MDBF team	Overview of the Power Pack from RIT point of view	Århus, Sonnesgade
32	09.10.2014	Søren Børsting	DSB Maintenance	Planner MDBF team	Overview of the Brake System from RIT point of view	Århus, Sonnesgade
33	10.10.2014	Søren Børsting	DSB Maintenance	Planner MDBF team	Visiting of a IC4 train in the workshop	Århus, Sonnesgade
34	10.10.2014	Bjarke V.	DSB Maintenance	Site Survey Augustenborggade	Workshop inspection	Århus, Augustenborggade
35	10.10.2014	Christian Rubinstein	DSB Economics	Financial Input	Required financial figures	Århus, Sonnesgade
36	10.10.2014	Steen S. Christensen Lars Wrist Elkjær Ove Dahl Kristensen	DSB Maintenance IC4PT Management IC4 PT Management	CEO Management COO Expert	Status report of IC4 Assessment	Århus, Sonnesgade
37	28.10.2014	Inge Brandbye Mikael Obelitz Steffen Knudsen	IC4 PT Engineering IC4 PT Engineering IC4 PT Quality	TCMS Manager TCMS Specialkonsulent Quality Manager	QM / TCMS SW processes	Høje Tåstrup
38	28.10.2014	Leif Funch Alexander Tived Joakim Böcher Per Hein	National Safety Authority / TS National Safety Authority / TS National Safety Authority / TS DSB Safety	Supervision, Certification Safety consultant Safety assessment consultant Safety Expert	Interview NSA/TS knowledge to relationship Collaboration to DSB Understanding Executive Order specific to IC4-2	Høje Tåstrup
39	29.10.2014	Inge Brandbye Mikael Obelitz Steffen Knudsen Michael Lessing José Luis López de Diego	IC4 PT Engineering IC4 PT Engineering IC4 PT Quality IC4 PT Engineering IC4 PT Engineering	TCMS Manager TCMS Specialkonsulent Quality Manager TCMS TCMS	QM / TCMS SW processes Specific SW modification related to CFG acc. P11 QMS SW Transfer Team	Høje Tåstrup
40	30.10.2014	Steffen Knudsen Carsten T. Pedersen Finn Jensen	IC4 PT Quality IC4 PT Engineering IC4 PT Engineering	Quality Manager CFG-Project Manager CFG-Project Manager / Integrator	QM / HW processes Specific HW CFG review	Høje Tåstrup
41	30.10.2014	Brian Andersen	DSB Maintenance	Site Survey KAC	Workshop inspection	KAC (Kopenhagen Airport)
42	30.10.2014	Søren Børsting	DSB Maintenance	Planner MDBF team	MDBF improvement Goal	Høje Tåstrup
43	30.10.2014	Steen S. Christensen	DSB Maintenance	CEO Management	MDBF Goals	Høje Tåstrup
44	30.10.2014	Lars Wrist Elkjær	IC4 PT Management	COO	Planned / Realized Hours Workshop	Høje Tåstrup

Project-ID :	14.104.00
Project:	Expert Assessment of IC4/2
Status:	05.11.2014

\*Note: Jesper Bruun Johansen, DSB Assessment leader, took part to each meeting.

Nb.	Date	Person(s)*	Departement / Organisation	Title	Subject and purpose	Location
45	31.10.2014	Nete Brehm Nielsen Steen Holm Flemming V. Jensen	DSB Maintenance Quality DSB Maintenance Quality DSB Maintenance Quality	Auditor/Editor of QMS  Head of maintenance safety envir.	QM – DSB Maintenance Knowledge of quality politics, specific SW processes and interdisciplinary workflow	Høje Tåstrup
46	31.10.2014	Søren Juhl	IC4 PT Engineering	IC4 R&D Manager	CFG-Implementation	Høje Tåstrup
47	31.10.2014	Christian Rubinstein	DSB Economics	Clarification Meeting Financial Inputs	Financial input to IC4-2 EXPA	Høje Tåstrup



Project-ID : 14.104.00 Latest registered date of receipt: 02.12.2014  
 Project: Expert Assessment of IC4/2

PROSE PROJECT internal document number	Obsolete	Document Name	Document ID Issuer	Revision	Date	Language	Issuer	Format	Date receipt	receipt by	Source receipt	Type	Category	PROSE Document ID	Content	
001		ATKINS IC4-IC2 Review - Background Report	5105273.001/002	1	19.10.2011	E	ATKINS	pdf		E-Mail	DSB	R	Technical	04-13-01397-E00		
002		DB Undersøgelse zu Lager- und Dämpferschäden an den Fahrzeugen IC2 und IC4 der DSB	14-17462-DSB-140312-01	1.10	04.07.2014	G	DB	pdf		E-Mail	DSB	R	Technical	04-13-01392-E00		
003		Extract from the report to the Public Accounts Committee on DSB's procurement and completion of IC4 and IC2 trains			01.06.2012	E	RIGSREVISIONEN	pdf		E-Mail	DSB	M	Information	04-13-01415-E00	REPORT ON DSB'S PROCUREMENT AND COMPLETION OF IC4 AND IC2 TRAINS	
004		DSB Deployment for IC4			14.08.2014	D	DSB	pptx		E-Mail	DSB	P	Reliability			
005		Preliminary info to PROSE Ltd IC4-2 Exp assess 2014-1			n.a.	n.a.	E	DSB	docx		E-Mail	DSB	M	Information		
006		DSB SAFETY CASE For IC4 Litra MG	P000271054	8AE	23.01.2014	E	DSB	docx		E-Mail	DSB	R	Technical		including train overview	
007		Technical specification for PowerPack	PMT-AA01J3C	2	23.04.2002	E	AB	pdf		E-Mail	DSB	R	Technical			
008		IC4 general Layout drawing		0	23.10.2002	E	AB	pdf		E-Mail	DSB	D	Technical			
009		AA02WTL - IC2 GENERAL LAYOUT		1	23.05.2003	E	AB	pdf		E-Mail	DSB	D	Technical			
010		IC4 design info for Proce Phase 1			n.a.	n.a.	E	DSB	docx	21.08.2014	E-Mail	DSB	M	Technical		
011		List of SFDDs (Subsystem Functional and Design Description)			20.08.2014	E	DSB	pdf	21.08.2014	E-Mail	DSB	R	Technical			
012		SFDD DSD (Driver safety device)	AA03Y1K	6	12.09.2007	E	AB	doc	21.08.2014	E-Mail	DSB	R	Technical			
013		IC4 Authority approval process documentation delivery status	AQU IO/045	22AI	03.02.2014	E	DSB	pdf	22.08.2014	E-Mail	DSB	R	Technical			
014		DSB - IC4/2 EXPA - Interviews			25.08.2014	E	DSB	docx	25.08.2014	E-Mail	DSB	M	Organisational			
015		IC4 Programme Top Down Meeting with Management 26.08.2014 IC4-2 EXPA			27.08.2014	E/D	DSB	pdf	28.08.2014	E-Mail	DSB	P	Information			
016		Oganisation as pr 1 september				D	DSB	pdf	28.08.2014	E-Mail	DSB	P	Organisational			
017		Management meeting Time line highlights				E	DSB	docx	28.08.2014	E-Mail	DSB	R	Information			
018		IC4 Brakeblending				D	DSB	pdf	28.08.2014	E-Mail	DSB	P	Technical			
019		Udmattelse Mekanik (Measurements Damper and axlebox)				E/G	DSB	pptx	28.08.2014	E-Mail	DSB	P	Technical			
020		Arbejdsinstruktion CFG-DSB0221 HVAC Førerrum fjernelse af blænde til varmeveksler	P000262259	01	24.06.2013	D	DSB	doc	28.08.2014	E-Mail	DSB	R	Technical			
021		CFG-DSB0221 HVAC Førerrum fjernelse af blænde til varmeveksler	P000246734	01	14.05.2013	D	DSB	doc	28.08.2014	E-Mail	DSB	R	Technical			
022		CSM Ekspertvurdering CFG-DSB0221 HVAC Førerrum fjernelse af blænde til varmeveksler	P000246963		05.06.2013	D	DSB	doc	28.08.2014	E-Mail	DSB	R	Technical			
023		Godkendelseserklæring vedr hasardidentifikation - CFG- DSB0221_signeret	P000259314	1	19.06.2013	D	DSB	pdf	28.08.2014	E-Mail	DSB	R	Technical			
024		Konstruktionsgranskingsrapport_integrator HVAC førerrum fjernelse af blændeCFG DSB0221	P000274307	01	04.12.2013	D	DSB	doc	28.08.2014	E-Mail	DSB	R	Technical			
025		Operatør selvkontrol CFG-DSB0221 HVAC Førerrum fjernelse af blænde til varmeveksler	P000262260	01	25.06.2013	D	DSB	doc	28.08.2014	E-Mail	DSB	R	Technical			
026		Systembeskrivelse og Kravspecifikation CFG-DSB0221 HVAC Førerrum fjernelse af blænde til varmeveksle	P000246939	01	13.05.2013	D	DSB	doc	28.08.2014	E-Mail	DSB	R	Technical			
027		Validerings rapport integrator HVAC Førerrum fjernelse af blænde CFG DSB 0221	P000274317	01	08.12.2013	D	DSB	doc	28.08.2014	E-Mail	DSB	R	Technical			
028		Verifikationsrapport CFG-DSB0221	P000271728	01	02.09.2013	D	DSB	doc	28.08.2014	E-Mail	DSB	R	Technical			
029		IC2 - km			31.08.2014	D	DSB	xlsx	01.10.2014	E-Mail	DSB	M	Information			
030		IC4 - km			31.10.2014	D	DSB	xlsx	19.11.2014	E-Mail	DSB	M	Information			
032		Referat møde 3. IC4 SG			21.08.2014	D	DSB	docx	28.08.2014	E-Mail	DSB	M	Information		minutes of meetings from the IC4 Steering Group meeting	
033		MG MDBF jun 13 jul 14				D	DSB	xlsx	28.08.2014	E-Mail	DSB	M	Information			
034		SFDD TC (Train Computer)	AA040JH	13	27.05.2014	E	DSB	pdf	01.09.2014	E-Mail	DSB	R	Technical			
035		Prose møde 26 aug 2014			26.08.2014	E	DSB	ppt	05.09.2014	E-Mail	DSB	P	Information			
036		IC4-2 DSB Interviewees-W37-5			04.09.2014	E	DSB	docx	04.09.2014	E-Mail	DSB	M	Organisational			
037a		Brake Equipment	SA-3992 (AA01K6D)	AP	10.04.2009	E	FT	pdf	05.09.2014	E-Mail	DSB	D	Technical			
037b		Brake Equipment Vehicle M1C	SA-3993 (AA01K6D)	AP	10.04.2009	E	FT	pdf	05.09.2014	E-Mail	DSB	D	Technical			
037c		Brake Equipment Vehicle T2HK-T3	SA-3994 (AA01K6D)	AP	10.04.2009	E	FT	pdf	05.09.2014	E-Mail	DSB	D	Technical			
037d		Brake Equipment Vehicle M4C	SA-4144 (AA01K6D)	AP	10.04.2009	E	FT	pdf	05.09.2014	E-Mail	DSB	D	Technical			
38		General Description Brake Equipment for DMU GTA IC4 Denmark	AA01KD4	10	10.04.2009	E	FT	pdf	05.09.2014	E-Mail	DSB	R	Technical			
39		Brake Disc - Thermal and wear calculation	AA01VBC	02	24.07.2002	E	KB	pdf	05.09.2014	E-Mail	DSB	R	Technical			
40		DMU IC4 SUBSYSTEM FUNCTIONAL AND DESIGN DESCRIPTION	AA03Y1U	13	09.10.2008	E	AB	pdf	05.09.2014	E-Mail	DSB	S	Technical			
41		Traction brake functional schematic diagram	AA04502	01	14.12.2004	E	AB	pdf	05.09.2014	E-Mail	DSB	D	Technical			
42		Emergency Brake Calculation	TA27304-75	04	20.01.2005	E	KB	pdf	05.09.2014	E-Mail	DSB	R	Technical			
43		Parking brake calculation	TA27304-72	05	20.01.2005	E	KB	pdf	05.09.2014	E-Mail	DSB	R	Technical			
44		Security brake calculation	TA27304-77	04	20.01.2005	E	KB	pdf	05.09.2014	E-Mail	DSB	R	Technical			
45		Service brake calculation (Pneumatic + E.P.)	TA27304-76	04	20.01.2005	E	KB	pdf	05.09.2014	E-Mail	DSB	R	Technical			
46		Service brake calculation (Pneumatic + 100% H.D. with E.P.)	TA27304-79	04	20.01.2005	E	KB	pdf	05.09.2014	E-Mail	DSB	R	Technical			
47		SFDD Brake	AA03Y1U	13	09.10.2008	E	AB	pdf	05.09.2014	E-Mail	DSB	R	Technical			
48		SFDD Traction	AA03Y1M	10	17.10.2008	E	AB	doc	05.09.2014	E-Mail	DSB	R	Technical			
49		SFDD Desk Key	AA03Y1P	4	29.10.2008	E	AB	pdf	05.09.2014	E-Mail	DSB	R	Technical			
50		SFDD DLU (DATA LOGGER UNIT)	AA03Y1Y	4/AA	14.09.2012	E	AB	doc	05.09.2014	E-Mail	DSB	R	Technical			
51		SFDD ATC (Automatic Train Control System)	AA03Y1L	3	10.10.2008	E	AB	doc	05.09.2014	E-Mail	DSB	R	Technical			
52		SFDD ARG (Axle Reverse Gear)	AA040JF	5	13.11.2007	E	AB	doc	05.09.2014	E-Mail	DSB	R	Technical			
53		SFDD Powering	AA03Y1Z	7AA	18.11.2008	E	AB	pdf	05.09.2014	E-Mail	DSB	R	Technical			
54		SFDD Radio	AA03Y1V	2	03.05.2006	E	AB	doc	05.09.2014	E-Mail	DSB	R	Technical			
55		SFDD Doors	AA03Y1T	4/AC	29.01.2014	E	AB	doc	05.09.2014	E-Mail	DSB	R	Technical			
56		SFDD PIS (Passenger Information System)	AA040JJ	5	06.02.2009	E	AB	doc	05.09.2014	E-Mail	DSB	R	Technical			
57		SFDD TRIT (DSB wireless transmission system)	AA040JK	4	25.11.2008	E	AB	doc	05.09.2014	E-Mail	DSB	R	Technical			
58		SFDD HVAC (Heating, Ventilation and Air Condition for Passengers Compartments)	AA03Y1R	6/AC	15.03.2013	E	AB	doc	05.09.2014	E-Mail	DSB	R	Technical			
59		SFDD HVAC (Heating, Ventilation and Air Condition for Drivers Cabin)	AA03Y1X	6/AB	22.07.2014	E	AB	doc	05.09.2014	E-Mail	DSB	R	Technical			
60		SFDD IDU (Integrated diagnostic unit)	AA05HEU	24	23.07.2013	E	AB	pdf	05.09.2014	E-Mail	DSB	R	Technical			
61		SFDD Toilettes	AA040JR	2	31.10.2008	E	AB	doc	05.09.2014	E-Mail	DSB	R	Technical			
62		SFDD Coupling	AA03Y1N	7	27.03.2009	E	AB	doc	05.09.2014	E-Mail	DSB	R	Technical			
63		SFDD INDOOR CAB AND EXTERNAL LIGHTING	AA03Y1W	5	31.10.2008	E	AB	doc	05.09.2014	E-Mail	DSB	R	Technical			
64		SFDD Miscellaneous	AA040JP	6	03.11.2008	E	AB	doc	05.09.2014	E-Mail	DSB	R	Technical			
65		DMU Danimarca - General Winter Configuration Layout		4	14.09.2009	E	AB	pdf	29.08.2014	Hardcopy	DSB	D	Technical			

Project-ID : 14.104.00 Latest registered date of receipt: 02.12.2014  
 Project: Expert Assessment of IC4/2

PROSE PROJECT internal document number	Obsolete	Document Name	Document ID Issuer	Revision	Date	Language	Issuer	Format	Date receipt	receipt by	Source receipt	Type	Category	PROSE Document ID	Content
66		DMU IC4 - Underframe Layout		3	14.03.2002	E	AB	pdf	29.08.2014	Hardcopy	DSB	D	Technical		
67		DMU IC4 - Devices Layout on the Bogies		3	28.02.2003	E	AB	pdf	29.08.2014	Hardcopy	DSB	D	Technical		
68		DMU IC4 - Schema Bus di Treno / Train Bus Diagram		0	15.07.2004	E	AB	pdf	29.08.2014	Hardcopy	DSB	D	Technical		
69		HW CONFIGURATION TRAIN MONITORING CONTROL SYSTEM DMU IC4		07	16.12.2009	I	AB	pdf	29.08.2014	Hardcopy	DSB	D	Technical		
70		RIT_dagligopfølgning_TDO			28.01.2014	D	DSB	pdf	08.09.2014	E-Mail	DSB	M	Organisational		Describes the daily progress TDO (Technical Operation Follow-up) for RIT (Reliability improvement team) responsibilities
71		RIT_dagligopfølgning_TDO_swim			28.01.2014	D	DSB	pdf	08.09.2014	E-Mail	DSB	M	Organisational		Process flow of daily progress of TDO (Technical Operation Follow-up) and RIT (Reliability improvement team)
72		RIT_Processen			28.01.2014	D	DSB	pdf	08.09.2014	E-Mail	DSB	M	Organisational		Process of RIT (Reliability improvement team)
73		RIT_Processen_swim			28.01.2014	D	DSB	pdf	08.09.2014	E-Mail	DSB	M	Organisational		Process flow of RIT (Reliability improvement team)
74		Priøret 0-stillinger 05-09-14			05.09.2014	D	DSB	xlsx	08.09.2014	E-Mail	DSB	M	Technical		Workshop Top 10 implementation prioritizing at workshop
75		Changes in existing vehicles - Flowchart for the approval process				E	DSB	pptx	09.09.2014	E-Mail	DSB	P	Organisational		
76		Tilladelse til kørsel med IC4 og IC2 (P14)		2	23.07.2014	D	DSB	pdf	09.09.2014	E-Mail	DSB	M	Organisational		Process trains permission to drive after changing trains
77		Bogier og løbetsl	2000 / 230	C03	17.07.2014	D	DSB	pdf	09.09.2014	E-Mail	DSB	S	Maintenance		Bogie maintenance instruction
78		IC4/IC2 CAPEX - wrap up from interview			10.09.2014	E	DSB	pdf	11.09.2014	E-Mail	DSB	M	Information		
79		Presentation of TCMS Software Pack-2.1 and Pack-2.2a ver. 2				E	DSB	ppt	12.09.2014	E-Mail	DSB	P	Technical		
80		IDU Pack 2.1 Baseline	AA0860H	15	21.06.2013	E	AB	pdf	12.09.2014	E-Mail	DSB	S	Technical		
81		TCMS Pack 2.1 Baseline 12_08	AA087RP	09	08.08.2013	E	AB	pdf	12.09.2014	E-Mail	DSB	S	Technical		
82		GTW Pack 2.1 Baseline 04	AA087RR	05	11.06.2013	E	AB	pdf	12.09.2014	E-Mail	DSB	S	Technical		
83		IDU Pack 2.2.a Baseline Package 2.2.a	AA0860H	25	19.04.2014	E	AB	pdf	12.09.2014	E-Mail	DSB	S	Technical		
84		Presentation of TCMS Software Mu4 (Mu3+)				E	DSB	ppt	16.09.2014	E-Mail	DSB	P	Technical		
85		IDU Pack Mu4 Baseline 27 package Multiple 4	AA087ZY	5	14.07.2014	E	AB	pdf	12.09.2014	E-Mail	DSB	S	Technical		
86		TCMS Pack Mu4 Baseline 15 Package Mu4	AA087ZX	4	14.07.2014	E	AB	pdf	12.09.2014	E-Mail	DSB	S	Technical		
87		GTW Pack Mu4 Baseline 05 Package Multiple4	AA087ZZ	3	14.07.2014	E	AB	pdf	12.09.2014	E-Mail	DSB	S	Technical		
88		Execution version Sub-Appendix 11.3 Requirement Spec Software Package IC4 2				E	DSB	pdf	12.09.2014	E-Mail	DSB	S	Technical		contractual requirements due to specification is under development (specifications not yet finalized)
89		Execution version Sub-Appendix 11.6 Requirement Spec Software Package IC2 Porting to IC4 Level				E	DSB	pdf	12.09.2014	E-Mail	DSB	S	Technical		contractual requirements due to specification is under development (specifications not yet finalized)
90		DSB Deployment plan 2019 for IC4			16.09.2014	E	DSB	pptx	16.09.2014	E-Mail	DSB	P	Reliability		
91		List of CFG implemented on each Trainset			16.09.2014	D	DSB	xlsx	16.09.2014	E-Mail	DSB	M	Technical		
92		Executive Order no. 56 on the Approval of Railway Vehicles			24.01.2013	E	NSA	pdf	n.a.	n.a.	n.a.	S	Approval		
93		DSB Deployment plan 2016 - 2030			08.09.2014	D	DSB	pptx	17.09.2014	E-Mail	DSB	P	Information		
94		Kravspecifikation CFG-DSB-0161(P000231289)	P000231289	1	04.07.2012	D	DSB	pdf	23.09.2014	E-Mail	DSB	R	Technical		
95		CFG0167 - Schedule B - Requirement specification - front gaiter CR4(P000238613)	P000238613	1	27.09.2012	E	DSB	pdf	23.09.2014	E-Mail	DSB	S	Technical		
96		CFG0168 - Kravspec - TC håndtering front gaiter(P000232610)	P000232610	1	09.07.2013	D	DSB	pdf	23.09.2014	E-Mail	DSB	R	Technical		
97		CFG0169 - kravspec - elkasser samtidigt(P000233766)	P000233766	2	09.07.2013	D	DSB	pdf	23.09.2014	E-Mail	DSB	R	Technical		
98		Justering af el-kasser(P000246037)	1400-031	1	12.06.2012	D	DSB	pdf	23.09.2014	E-Mail	DSB	W	Technical		
99		SFDD Manual Coupler(P000272818)	FE02P31000B	5	04.06.2013	E	AB	doc	25.09.2014	E-Mail	DSB	S	Technical		
100		TCMS experience list 7.15(P000270324)	P000270324	7	15.10.2012	E	unclear	xlsx	25.09.2014	E-Mail	DSB	S	Technical		
101		TCMS pack 2.1 Single Static Test Procedure Rev.3(P000254148)	VER/VPT AA087R7	3	11.06.2013	E	AB	pdf	25.09.2014	E-Mail	DSB	S	Technical		
102		Kravspecifikation drænhul i stik CFG-DSB0255			17.07.2014	D	DSB	doc	26.09.2014	E-Mail	DSB	S	Technical		
103		Kravspecifikation CFG-DSB0250(P000275380)	P000275380		20.01.2014	D	DSB	doc	26.09.2014	E-Mail	DSB	S	Technical		
104		Kravspec Reco antennefflytning CFG-DSB0113(P000230677)	P000230677	1	27.12.2014	D	DSB	pdf	26.09.2014	E-Mail	DSB	S	Technical		
105		TCMS pack 2 Findings assessment by AB and DSB final 7-7-2011(P000219399)	P000219399	19	n.d.	E	n.d.	xlsx	26.09.2014	E-Mail	DSB	S	Technical		
106		Not used													
107		TIP IC4 plan - V2				D	DSB	xism	17.09.2014	E-Mail	DSB	M	Information		
108		Design and development of hardware changes to trains IC4-QM-P10	P10.10	2	21.07.2014	D	DSB	pdf	19.09.2014	E-Mail	DSB	R	Organisational		
109		Design and development of software modifications to trains IC4-QM-P11	P11	1	11.11.2014	D	DSB	pdf	19.09.2014	E-Mail	DSB	R	Organisational		
110		Implementation of modifications to the IC2 / IC4 trains IC4-QM-P12	P12	2	3.29.08.2014	D	DSB	pdf	19.09.2014	E-Mail	DSB	R	Organisational		
111		Teknikmøde - Technical meeting 19092014			19.09.2014	D	DSB	ppt	23.09.2014	E-Mail	DSB	P	Reliability		Monthly steering comitee meeting (prioritise CGF)
112		Cenelec kode IC4 Model		1	30.10.2006	E	DSB	pdf	24.09.2014	E-Mail	DSB	S	Technical		
113		CFG info til PROSE version update AF 17-10 - 05-11-2014			05.11.2014	D	DSB	xlsx	05.11.2014	E-Mail	DSB	M	Technical		last version delivered
114		DMU IC4 NT weight status (train nb.14)	AA07LKZ	R0	27.04.2008	E	AB	xps	26.09.2014	E-Mail	DSB	R	Technical		
115		DMU IC4 PTO Train 22 weight status (P000163009)	AA084EC	00	25.03.2009	E	AB	pdf	26.09.2014	E-Mail	DSB	R	Technical		
116		Weight handling trainset 10	AA05HX1	1	04.03.2006	E	AB	xps	26.09.2014	E-Mail	DSB	R	Technical		
117		Lower Part of Axlebox Z.176466 (040803) - Stress Analysis for Lower Part under Damper Loads - Project IC4 - DSB, Ansaldobreda			11.03.2011	E	FAG	pdf	26.09.2014	E-Mail	DSB	R	Technical		
118		Statement_DB Mindens report in relation to AB's measurements			27.08.2014	D	DSB	docx	26.09.2014	E-Mail	DSB	R	Technical		
119		Action plan Axle Boxes addressed			27.08.2014	D	DSB	docx	26.09.2014	E-Mail	DSB	R	Technical		Draft Action Plan for IC4 axle boxes justified by DB Minden report, compared to AB's measurements on the train and own statistics on the train.
120		IC4-2 PROSE-DSB Interview for Week 40-2014			26.09.2014	E	DSB	docx	26.09.2014	E-Mail	DSB	M	Organisational		
121		DMU - IC4 MEASUREMENT ACTIVITY ON JOURNAL BOXES OF IC4 MOTOR BOGIE IN SERVICE		00	03.07.2014	E	AB	pdf	26.09.2014	E-Mail	DSB	R	Technical		
122		R2-Sub-Appendix 6.4a Propulsion Package		0	20.11.2000	E	AB	pdf	29.09.2014	E-Mail	DSB	S	Technical		Tender documentation: Description of the propulsion package
123		Technical Description Master Controller	DT-451755	C	27.02.2004	E	Sab Wabco	pdf	29.09.2014	E-Mail	DSB	S	Technical		Technical specification Master Controller
124		Power Pack Procedure	428_LG_DP_02_10	3	14.11.2007	E	ELTRAC	pdf	29.09.2014	E-Mail	DSB	S	Technical		Project documentation Power Pack Procedure
125		ENGINE TORQUE CALCULATION	428_LG_DP_01_04	1	15.11.2002	E	ELTRAC	pdf	29.09.2014	E-Mail	DSB	S	Technical		Project documentation: Engine torque calculation
126		ELECTRIC LOADS ESTIMATION	AA037LG	1	11.11.2003	E	AB	pdf	29.09.2014	E-Mail	DSB	S	Technical		Electric Loads estimation
127		Afdrejning oversigt				D	DSB	xlsx	30.09.2014	E-Mail	DSB	R	Technical		Overview of the wheel reprofiling
128		140829 WILD Lillebælt			29.08.2014	D	DSB	pptx	30.09.2014	E-Mail	DSB	P	Technical		Presentation of WILD Control System (Wheel Loads on track)
129		Taskforce IC4 brems 2014 - 19 sep - 1			19.09.2014	D	DSB	ppt	30.09.2014	E-Mail	DSB	P	Technical		Action plan brake

Project-ID : 14.104.00 Latest registered date of receipt: 02.12.2014  
 Project: Expert Assessment of IC4/2

PROSE PROJECT internal document number	Obsolete	Document Name	Document ID Issuer	Revisi on	Date	Langua ge	Issuer	Format	Date receipt	receipt by	Source receipt	Type	Category	PROSE Document ID	Content
130		Preventive maintenance activities for bogies	2000-ic4-230	A02	12.09.2014	E	DSB AB	pdf	18.09.2014	E-Mail	DSB	W	Maintenance		
131		Weight - Wheel load measurements trainset 15			07.04.2014	I	DSB	pdf	01.10.2014	E-Mail	DSB	R	Technical		IC4 transet no.15 after DSB has rebuild the train for the test with the TCMS pack 2.1. Weight and axel load within the demands in routine test (DRDT 03)
132		DRDT3 MG5615			07.04.2014	I	DSB	pdf	01.10.2014	E-Mail	DSB	R	Technical		
133		DSAT 16 DYNAMIC PERFORMANCE STARTING AND ACCELERATION AT TARA LOAD (P000203267) trainset 01	AA02JE0	00	06.04.2005	E	AB	pdf	01.10.2014	E-Mail	DSB	R	Technical		
134		DSAT 17 DYNAMIC PERFORMANCE STARTING AND ACCELERATION AT FULL LOAD (P000203270) trainset 01	AA02JEs	00	21.04.2005	E	AB	pdf	01.10.2014	E-Mail	DSB	R	Technical		
135		DFAT 1 CARBODY STRUCTURAL TEST(P000204234)	AA02TBJ	1	05.01.2005	E	AB	pdf	01.10.2014	E-Mail	DSB	R	Technical		
136		DSAT29-1 Brake Section Test Report Section A (P000209243)	AA07K6R	03	02.03.2009	E	AB	pdf	01.10.2014	E-Mail	DSB	R	Technical		
137		DSAT29-1 Brake Section Test Report Section B (P000209210) train 11	AA07K6W	01	end of 2008	E	AB	pdf	02.10.2014	E-Mail	DSB	R	Technical		
138		DSAT29-1 Brake Section Test Report Section G (P000208234)	AA06ZK0	03	27.02.2008	E	AB	pdf	03.10.2014	E-Mail	DSB	R	Technical		
139		DFAT 3 Springs Test Report (P000199088)	AA020KC	02	02.07.2004	E	AB & Phönix	pdf	03.10.2014	E-Mail	DSB	R	Technical		
140		Not used													
141		Luft flow train nb. 5881			13.03.2014	D	DSB	doc	03.10.2014	E-Mail	DSB	M	Technical		
142		DSAT 29/1 (ATTACHMENT) TRACTION	AA03V41	9		E	AB	pdf	03.10.2014	E-Mail	DSB	R	Technical		
143		Guidelines for the RCM Analysis & Maintenance Program	AA01JDA	1	10.04.2001	E	AB	doc	03.10.2014	E-Mail	DSB	R	Technical		
144		RCM ANALYSIS AND MAINTENANCE PROGRAM	AA022KM	12	19.09.2013	E	AB	pdf	03.10.2014	E-Mail	DSB	R	Technical		
145		RCM ANALYSIS AND MAINTENANCE PROGRAM DOCUMENT - INTERIORS	AA038M9	15	18.09.2013	E	AB	pdf	03.10.2014	E-Mail	DSB	R	Technical		
146		RCM ANALYSIS & MAINTENANCE PROGRAM - CONTROL & COMMUNICATIONS	AA038MA	14	18.09.2013	E	AB	pdf	03.10.2014	E-Mail	DSB	R	Technical		
147		IC4 Preventive Maintenance Program	AA046N9	11	19.09.2013	E	AB	pdf	03.10.2014	E-Mail	DSB	R	Maintenance		
148		IC4 Preventive Maintenance Program	AA046N9	11	19.09.2013	E	AB	xls	03.10.2014	E-Mail	DSB	R	Technical		
149		IC2 Preventive Maintenance Program	AA085V3	1	15.12.2011	E	AB	pdf	03.10.2014	E-Mail	DSB	R	Technical		
150		Axel Box Inspection @ 30 Mm (due to crack findings early 2014)	Al- 2000-046	3	19.09.2014	D	DSB	pdf	03.10.2014	E-Mail	DSB	R	Technical		
151		Arbejdsinstruktion CFG-DSB0161 Kabelføring Elkasser(P000240620)	P000240620	2	29.10.2012	D	DSB	pdf	03.10.2014	E-Mail	DSB	R	Technical		
152		CFG0167 Evalueringsskema udbud af gater(P000245942)	P000245942			D	DSB	xls	03.10.2014	E-Mail	DSB	R	Technical		
153		CFG0167 gater prototype test protokol(P000244883)	P000244883			D	DSB	xls	03.10.2014	E-Mail	DSB	R	Technical		
154		CFG0167 prototyper statsk test århus(P000244912)	P000244912			D	DSB	pdf	03.10.2014	E-Mail	DSB	R	Technical		
155		D4-87355_5_En AC		5		E	Delner?	pdf	03.10.2014	E-Mail	DSB	R	Technical		
156		Offar Coupler Modification	2014-0567		19.06.2014	E	Delner	pdf	03.10.2014	E-Mail	DSB	M	Information		
157		Delner Certificate of compliance nr 122 & 202	1013	7	27.06.2014	E	Delner	pdf	03.10.2014	E-Mail	DSB	R	Production		
158		SFDD Coupling Rev7AB (P000278276)	P000278276	07/AB	26.06.2014	E	DSB	pdf	03.10.2014	E-Mail	DSB	S	Technical		
159		Overhaul Manual AUTOMATIC COUPLER	D4-87353	2	June 2005	E	Delner	pdf	03.10.2014	E-Mail	DSB	W	Production		
160		DSB TCMS transfer team			03.10.2014	E	DSB	mail	03.10.2014	E-Mail	DSB	W	Organisational		
161		MDBF for PROSE v1		00	06.10.2014	E	DSB	pdf	07.10.2014	E-Mail	DSB	R	Technical		
162		Inspection Report FAG	213207365		28.03.2011	E	DSB	pdf	03.10.2014	E-Mail	DSB	R	Technical		
163		Investigation Report Axlebox	IBT-R/U021321		30.04.2002	E	FAG	pdf	03.10.2014	E-Mail	DSB	R	Technical		
164		Investigation Report Axlebox Enclosures	IBT-R/U021321 - Appendicies		30.04.2002	E	FAG	pdf	03.10.2014	E-Mail	DSB	R	Technical		
165		Investigation_Report_Axlebox_U031302	IBT-R/U031302		01.02.2002	E	FAG	pdf	03.10.2014	E-Mail	DSB	R	Technical		
166		Report Primary Suspension Damper	110-23322		09.03.2010	E	FORCE Technology	pdf	03.10.2014	E-Mail	DSB	R	Technical		
167		Examination of fractured Axle Box	114-23061		25.02.2010	E	FORCE Technology	pdf	03.10.2014	E-Mail	DSB	R	Technical		
168		Drawing Radsatzlager	051-50000009385		26.02.2010	DE	FAG	pdf	03.10.2014	E-Mail	DSB	D	Technical		
169		AA01JKM R01VERTICAL DAMPER DIA. 45 ... (P000198123)	777204	01	03.07.2002	IT	GIMON	pdf	03.10.2014	E-Mail	DSB	D	Technical		
170		AA01JKW ELASTIC ELEMENT FOR JOURNAL BOX GUIDIN ARM ... (P000198392)	H3G00612	3	04.10.2002	IT	HTM Technology	pdf	03.10.2014	E-Mail	DSB	D	Technical		
171		Dæmperkarakteristikker					DSB?	xlsx	03.10.2014	E-Mail	DSB	R	Technical		Annex 3 to Action plan Axle Boxes addressed [119]
172		Indstilling vedrørende kontrol af hjul og akselkasser - IC4			30.07.2014	D	DSB	doc	03.10.2014	E-Mail	DSB	W	Technical		Annex 1 to Action plan Axle Boxes addressed [119]
173		Inspektionsinterval, indstilling, formateret			25.07.2014	D	DSB	doc	03.10.2014	E-Mail	DSB	W	Technical		Annex 1 to Action plan Axle Boxes addressed [119]
174		Kravspecifikation CFG-DSB0281 Ny primær støddæmper			28.08.2014	D	DSB	doc	03.10.2014	E-Mail	DSB	S	Technical		
175		PRIMARY SUSPENSION ASSEMBLY	AA020HG	5	21.07.2003	E	AB	JPG	03.10.2014	E-Mail	DSB	D	Technical		
176		Seneberg damper presentation				D	Senebergshocks	pdf	03.10.2014	E-Mail	DSB	P	Technical		
177		Seneberg damper, blow off				D	Senebergshocks	pdf	03.10.2014	E-Mail	DSB	P	Technical		
178		DSAT29-1 Brake Section Test Report (P000080141)_P 1-100	AA06DNU	2	29.11.2006	E	AB	pdf	02.10.2014	E-Mail	DSB	R	Technical		
179		DSAT29-1 Brake Section Test Report (P000080141)_P 101-185	AA06DNU	2	29.11.2006	E	AB	pdf	02.10.2014	E-Mail	DSB	R	Technical		
180		Change on PowerPack			01.10.2014	E	DSB	pdf	06.10.2014	E-Mail	DSB	P	Technical		
181		CFG0169 diagram skitse(P000239145)	P000239145		09.07.2013	D	DSB	vsd	08.10.2014	E-Mail	DSB	D	Technical		
182		CFG-DSB0168 electrical diagram_Rev1		1		D	DSB	pdf	08.10.2014	E-Mail	DSB	D	Technical		
183		Test rapport reco antenne flytning 10.8.2011(P000220665)	P000220665	0		E	DSB	pdf	08.10.2014	E-Mail	DSB	R	Technical		
184		Tilbud Blueprint Reco antenne + testresultatet fra måling i århus(P000232625)	P000232625		03.02.2012	D	Blueprint	pdf	08.10.2014	E-Mail	DSB	R	Technical		
185		Technical description PFA-switch	H72367		01.04.2014	E	Trafag	pdf	02.10.2014	E-Mail	DSB	S	Technical		
186		Factory acceptance tests - DFAT List - Appendix(P000275308)	AQU IO 045		01.01.2014	E	DSB	doc	02.10.2014	E-Mail	DSB	S	Technical		
187		DSAT's and Type tests - DSAT List - Appendix(P000275307)	AQU IO 045		01.01.2014	E	DSB	doc	02.10.2014	E-Mail	DSB	S	Technical		
188		Coupling PROSE_RIT			08.10.2014	E	DSB	pdf	09.10.2014	E-Mail	DSB	P	Information		
189		RIT Team PROSE			09.10.2014	E	DSB	pdf	09.10.2014	E-Mail	DSB	P	Information		
190		Stribelist				D	DSB	xlsx	09.10.2014	E-Mail	DSB	R	Information		
191		prose coupler evaluation cfg113				E	DSB	mail	09.10.2014	E-Mail	DSB	R	Technical		
192		Produktionsplan Augustenborggade 2014		2		D	DSB	xism	09.10.2014	E-Mail	DSB	R	Information		
193		synchronous decoupling 13K100z			08.06.2010	D	DSB	mail	09.10.2014	E-Mail	DSB	D	Technical		
194		Hours Workshop IC4 Solnes + augustenborggade - KAC added			31.10.2014	E	DSB	xlsx	31.10.2014	E-Mail	DSB	R	Production		Workshop hours IC4, last drop KAC hours added
195		Solnesgade Workshop Survey			09.10.2014	E	DSB	pptx	09.10.2014	E-Mail	DSB	R	Production		
196		Solnesgade Weekly Workshop Planning			09.10.2014	D	DSB	xlsx	09.10.2014	E-Mail	DSB	R	Production		
197		IC4 Maintenance Handbook MM Worktasks			09.10.2014	D	DSB	xlsx	09.10.2014	E-Mail	DSB	W	Production		

Project-ID : 14.104.00 Latest registered date of receipt: 02.12.2014  
 Project: Expert Assessment of IC4/2

PROSE PROJECT internal document number	Obsolete	Document Name	Document ID Issuer	Revision	Date	Language	Issuer	Format	Date receipt	receipt by	Source receipt	Type	Category	PROSE Document ID	Content
198		IC4 Kompetenceoversigt med kompetence hold			09.10.2014	D	DSB	xlsx	09.10.2014	E-Mail	DSB	R	Production		
199		IC4 Drift Uge Bemanding uge 42			09.10.2014	D	DSB	xlsx	09.10.2014	E-Mail	DSB	R	Production		
200		Minuets IC4-2 EXPA Steering Group Meeting 3			10.10.2014	E	DSB	doc	22.10.2014	E-Mail	DSB	M	Information		
201		Vertical Damper DIA45	P110126	01	03.07.2002	E	GIMON	pdf	23.10.2014	E-Mail	DSB	D	Technical		
202		MEASUREMENT ACTIVITY on JOURNAL BOXES of IC4 MOTOR BOGIE in SERVICE	LST/PPR/052	0	28.03.2011	E	AB	doc	23.10.2014	E-Mail	DSB	R	Technical		
203		To AB concerning test			29.04.2014	E	DSB	doc	23.10.2014	E-Mail	DSB	M	Technical		Requirements from DSB to AB reg. Measurements [202]
204		SV: comments Antwort: SV: [URGENT]: Request: Wheels, Axles, etc.			08.05.2014	E	DSB	mail	23.10.2014	E-Mail	DSB	M	Technical		Requirements from DSB/DB to AB reg. Measurements [202]
205		SV: IC4 Axle box Line Test			06.05.2014	E	DSB	mail	23.10.2014	E-Mail	DSB	M	Technical		Requirements from DSB to AB reg. Measurements [202]
206		Wheel manual "hjulmanualen"	MSTD2.002	3	25.04.2014	D	DSB	pdf	23.10.2014	E-Mail	DSB	W	Technical		including categorisation of wheel defects
207		IC4 DSB Technical Specifications Journal Box Assembly	LPC - AA01JL2	2	31.07.2002	D	DSB	pdf	23.10.2014	E-Mail	DSB	S	Maintenance		
208		Extract of contractual specifications related to axlebox bearing				E	DSB	docx	23.10.2014	E-Mail	DSB	S	Technical		
209		ANMIG0T.176466.A Journal Roller Bearing	051-500000006480	06		E	FAG	pdf	23.10.2014	E-Mail	DSB	D	Technical		
210		Fremstillingsstøj kobling tgs 18			25.03.2014	D	DSB	docx	21.10.2014	E-Mail	DSB	R	Technical		
211		Deltner - koblingsproblemer			17.04.2014	E	Deltner	mail	27.10.2014	E-Mail	DSB	R	Approval		
212		T1-1000 cyklus testrapport for 0-serie(A) CFG-DSB0167	P000272483	A	06.08.2013	D	DSB	mail	27.10.2014	E-Mail	DSB	R	Technical		
213		T1-1000 cyklus testrapport for 0-serie(B) CFG-DSB0167	P000273397	B	18.10.2013	D	DSB	mail	27.10.2014	E-Mail	DSB	R	Technical		
214		Test procedure - Koblingspakken - typetest	P000274196	0	21.11.2013	D	DSB	mail	27.10.2014	E-Mail	DSB	S	Technical		
215		Test rapport - Koblingspakken - typetest MG5602	P000274594	0	29.11.2013	D	DSB	mail	27.10.2014	E-Mail	DSB	R	Technical		
216		Test rapport - Koblingspakken - typetest MG5668	P000274596	0	29.11.2013	D	DSB	mail	27.10.2014	E-Mail	DSB	R	Technical		
217		Test rapport - Koblingspakken - typetest MG5802	P000274597	0	29.11.2013	D	DSB	mail	27.10.2014	E-Mail	DSB	R	Technical		
218		Test rapport - Koblingspakken - typetest MG5868	P000274598	0	29.11.2013	D	DSB	mail	27.10.2014	E-Mail	DSB	R	Technical		
219		Serial Test rapport Gater 5630	P000274061	0	22.08.2014	D	DSB	mail	27.10.2014	E-Mail	DSB	R	Technical		
220		Koblingspakken serie test procedure	P000273937	1	20.03.2014	D	DSB	mail	27.10.2014	E-Mail	DSB	S	Technical		
221		SV Fremsendelse af signifikansvurderinger (CFG DSB0113 161 165-169) - (TS approval of CFG packet)			27.08.2013	D	DSB	mail	27.10.2014	E-Mail	DSB	S	Technical		
222		MOVEMENT MEMBER ASSEMBLY SCHEME	P000275361	8		E	DSB	mail	27.10.2014	E-Mail	DSB	D	Technical		
223		CFG0168 Arbejdsinstruks TC håndtering front gaiter	P000239508	5	26.03.2014	D	DSB	mail	27.10.2014	E-Mail	DSB	S	Technical		
224		Arbejdsinstruktion til Produktion CFG-DSB0132	P000245579	0	03.09.2014	D	DSB	pdf	22.10.2014	E-Mail	DSB	R	Technical		
225		Grundlag for signifikansvurdering CFG-DSB0132	P000280655	0	15.09.2014	D	DSB	docx	22.10.2014	E-Mail	DSB	R	Technical		
226		Systembeskrivelse og Kravspecifikation CFG-DSB0132	P000245547	01	21.05.2013	D	DSB	pdf	22.10.2014	E-Mail	DSB	R	Technical		
227		Testprogram for CFG-DSB0132	P000272891	0	11.10.2013	D	DSB	docx	22.10.2014	E-Mail	DSB	R	Technical		
228		Vibrations rapport Ladeluftslanse stude itus CFG-DSB0132	P000280067	-	06.08.2014	-	Minus10dB	pdf	22.10.2014	E-Mail	DSB	R	Technical		
229		3200-ic4.17.32		-	-	D	DSB	docx	22.10.2014	E-Mail	DSB	S	Technical		
230		3200-ic4.17.34 3,4		-	-	D	DSB	docx	22.10.2014	E-Mail	DSB	S	Technical		
231		3200-ic4.17.33		-	-	D	DSB	docx	22.10.2014	E-Mail	DSB	S	Technical		
232		3200-IC4-TP_A01		-	-	D	DSB	docx	22.10.2014	E-Mail	DSB	S	Technical		
233		AA046WW Fra IVECO til AB		-	23.12.2004	D	DSB	docx	22.10.2014	E-Mail	DSB	S	Technical		
234		Arbejdsinstruktion til justering af generator på IC4 Power Pack	P000280423	-	18.08.2014	D	DSB	docx	22.10.2014	E-Mail	DSB	S	Technical		
235		Mecc Alte Magnetiseringskort Specifikationer	P000246903	-	-	D	DSB	docx	22.10.2014	E-Mail	DSB	S	Technical		
236		Peak DC.DC converter Specifikationer		-	-	D	DSB	docx	22.10.2014	E-Mail	DSB	S	Technical		
237		RIT-DSB0001 - Generator 2012	P000246895	-	01.11.2012	D	DSB	docx	22.10.2014	E-Mail	DSB	R	Technical		
238		Testrapport generator udfald	P000274726	-	-	D	DSB	docx	22.10.2014	E-Mail	DSB	R	Technical		
239		Maintenance PowerPack		-	22.10.2014	E	DSB	mail	22.10.2014	E-Mail	DSB	R	Technical		
240		RIT-DSB0032 Hydraulikpumpe	P000275048	-	11.12.2012	D	DSB	docx	22.10.2014	E-Mail	DSB	R	Technical		
241		RIT-DSB0048 ZF DC DC converter		02	NOT FINISHED	D	DSB	docx	22.10.2014	E-Mail	DSB	R	Technical		
242		Type Test Procedure PowerPack	DFAT14	2	08.11.2004	E	AB	pdf	22.10.2014	E-Mail	DSB	S	Technical		
243		CFG-DSB0092 Arbejdsinstruktion	P000221409	3	30.03.2011	D	DSB	docx	22.10.2014	E-Mail	DSB	R	Technical		
244		CFG-DSB0092 Rettelse til vedligeholdningsinstruktion	P000231991	A10	04.01.2012	D	DSB	docx	22.10.2014	E-Mail	DSB	R	Technical		
245		Kravspecifikation CFG-DSB0092	P000218184	-	19.05.2011	D	DSB	docx	22.10.2014	E-Mail	DSB	R	Technical		
246		Valideringsrapport CFG-DSB0092	P000219953	4	20.07.2011	D	DSB	docx	22.10.2014	E-Mail	DSB	R	Technical		
247		Kravspecifikation udstødsophæng for CFG-DSB0128	P000232422	2	15.11.2011	D	DSB	docx	22.10.2014	E-Mail	DSB	R	Technical		
248		Valideringsrapport integrator for CFG-DSB0128	P000235957	1	08.05.2012	D	DSB	docx	22.10.2014	E-Mail	DSB	R	Technical		
249		Vibrationsmåling-rapport CFG-DSB0128	P000246968	-	14.03.2013	D	DSB	pdf	22.10.2014	E-Mail	DSB	R	Technical		
250		Bilag 3 Testrapport Test af manifold spec og resume	P000279872	-	-	D	DSB	docx	22.10.2014	E-Mail	DSB	R	Technical		
251		Bilag 11 Testrapport Datablad hydraulik slange FC510 AQP	P000279873	-	-	E	Aeroutip	pdf	22.10.2014	E-Mail	DSB	S	Technical		
252		Grundlag for Signifikansvurdering for ændringer CFG-DSB0277 Revner i manifold	P000280372	1	29.08.2014	D	DSB	docx	22.10.2014	E-Mail	DSB	R	Technical		
253		Kravspecifikation CFG-DSB0277 Revner i manifold	P000280375	-	29.08.2014	D	DSB	docx	22.10.2014	E-Mail	DSB	R	Technical		
254		Kravspecifikation for CFG-DSB0131	P000237534	1	29.06.2012	D	DSB	docx	22.10.2014	E-Mail	DSB	R	Technical		
255		Test revnet udstødningsmanifold d. 02 07 2014 Testrapport	P000279867	1	04.08.2014	D	DSB	docx	22.10.2014	E-Mail	DSB	R	Technical		
256		Arbejdsinstruktion til klamps og flexrør for udstødningsmanifold CFG-DSB0187 0187_2	P000239695	5	11.04.2013	D	DSB	pdf	22.10.2014	E-Mail	DSB	R	Technical		
257		Final test af ny clamp CFG-DSB0187_2	P000273146	0	22.10.2013	D	DSB	docx	22.10.2014	E-Mail	DSB	R	Technical		
258		Rettelse til vedligeholdningsinstruktion(PMP) CFG-DSB0187_2	P000273168	-	24.10.2013	D	DSB	pdf	22.10.2014	E-Mail	DSB	S	Technical		
259		System og Kravspecifikation for CFG-DSB0187	P000239683	02	23.10.2012	D	DSB	docx	22.10.2014	E-Mail	DSB	S	Technical		
260		Tegning Clamp 134721CFG-DSB0187_2	P000273146	-	14.10.2013	E	Interlink	pdf	22.10.2014	E-Mail	DSB	D	Technical		
261		Test af ny Clamp CFG-DSB0187_2 (10-10-2013)	P000272852	00	10.10.2013	D	DSB	docx	22.10.2014	E-Mail	DSB	R	Technical		
262		Testprogram for CFG-DSB0187_2	P000271327	01	15.08.2013	D	DSB	docx	22.10.2014	E-Mail	DSB	R	Technical		
263		Testrapport CFG-DSB0187 & 0128	P000245744	0	25.03.2013	D	DSB	pdf	22.10.2014	E-Mail	DSB	R	Technical		
264		Valideringsrapport-integrator CFG-DSB0187_2	P000270078	0	24.10.2013	D	DSB	docx	22.10.2014	E-Mail	DSB	R	Technical		
265		Arbejdsinstruktion til produktion - CFG-DSB0230	P000276522	02	06.03.2014	D	DSB	pdf	22.10.2014	E-Mail	DSB	R	Technical		
266		DSB23695 Indsats udstødnings højre CFG-DSB0230 Dæmpning af støj i passagerafsnit	P000276484	-	10.01.2014	D	DSB	pdf	22.10.2014	E-Mail	DSB	D	Technical		
267		Grundlag for Signifikansvurdering CFG-DSB0230 Dæmpning af støj i passagerafsnit signeret	P000275303	01	09.12.2013	D	DSB	pdf	22.10.2014	E-Mail	DSB	R	Technical		
268		Kravspecifikation CFG-DSB0230 Dæmpning af støj i passagerafsnit	P000275281	02	13.01.2014	D	DSB	pdf	22.10.2014	E-Mail	DSB	R	Technical		
269		Testprogram CFG-DSB0230	P000274557	-	10.12.2013	D	DSB	docx	22.10.2014	E-Mail	DSB	R	Technical		
270		Testrapport CFG-DSB0230 Dæmpning af støj i passagerafsnit	P000276426	01	04.03.2014	D	DSB	docx	22.10.2014	E-Mail	DSB	R	Technical		

Project-ID : 14.104.00 Latest registered date of receipt: 02.12.2014  
 Project: Expert Assessment of IC4/2

PROSE PROJECT internal document number	Obsolete	Document Name	Document ID Issuer	Revision	Date	Language	Issuer	Format	Date receipt	receipt by	Source receipt	Type	Category	PROSE Document ID	Content
271		Testrapport minus 10 dB DSB IC4 Udstødning trykmåling og støj BILAG 4 CFG-DSB0230 Dæmpning af støj i	P000276427	-	26.02.2014	E	Minus10dB	pdf	22.10.2014	E-Mail	DSB	R	Technical		
272		Udstødningsdata temp 06022014 og 11022014 BILAG 5 CFG-DSB0230 Dæmpning af støj i passagerafsnit	P000276488	-	-		DSB	pdf	22.10.2014	E-Mail	DSB	R	Technical		
273		Valideringsrapport Integrator CFG-DSB0230 Dæmpning af støj i passagerafsnit	P000276467	01	05.03.2014	D	DSB	docx	22.10.2014	E-Mail	DSB	R	Technical		
274		Kravsifikation CFG-DSB0272 Optimering af lydpotte og reduktion af mottryk	P000278356	01	29.05.2014	D	DSB	docx	22.10.2014	E-Mail	DSB	R	Technical		
275		Arbejdsinstruktion til Produktion - CFG-DSB0246	P000279865	03	09.09.2014	D	DSB	docx	22.10.2014	E-Mail	DSB	R	Technical		
276		Description of the changes of dataset 145br09 - ASR parameters, Annex - CFG-DSB0246	P000279857	01	18.07.2014	E	FTP	pdf	22.10.2014	E-Mail	DSB	S	Technical		
277		Description of the changes of dataset 156br09 - ASR parameters - CFG-DSB0246	P000279856	01	18.07.2014	E	FTP	pdf	22.10.2014	E-Mail	DSB	S	Technical		
278		Testing report for missing traction with current dataset - CFG-DSB0246	P000279855	-	31.07.2014	E	FTP	pdf	22.10.2014	E-Mail	DSB	P	Technical		
279		IC4 meeting, Aarhus - CFG-DSB0246	P000273087	-	03.10.2013	E	FTP	pdf	22.10.2014	E-Mail	DSB	M	Technical		
280		Grundlag for signifikansvurdering CFG-DSB0246 - signeret	P000278207	01	26.05.2014	D	DSB	pdf	22.10.2014	E-Mail	DSB	R	Technical		
281		System og Kravsifikation - CFG-DSB0246	P000278206	01	02.06.2014	D	DSB	docx	22.10.2014	E-Mail	DSB	R	Technical		
282		Test rapport, testrun - CFG-DSB0246, signeret	P000279859	05	20.06.2014	D	DSB	pdf	22.10.2014	E-Mail	DSB	R	Technical		
283		Testrun minures - CFG-DSB0246	P000279819	-	18.06.2014	D	DSB	docx	22.10.2014	E-Mail	DSB	R	Technical		
284		Valideringsrapport - integrator - CFG-DSB0246	P000279860	01	18.08.2014	D	DSB	docx	22.10.2014	E-Mail	DSB	R	Technical		
285		Arbejdsinstruktion CFG-DSB0262	P000278694	01	02.06.2014	D	DSB	pdf	22.10.2014	E-Mail	DSB	R	Technical		
286		Grundlag for signifikansvurderinger CFG-DSB0262	P000278958	02	13.06.2014	D	DSB	docx	22.10.2014	E-Mail	DSB	R	Technical		
287		Kravsifikation CFG-DSB0262	P000278908	02	12.06.2014	D	DSB	docx	22.10.2014	E-Mail	DSB	R	Technical		
288		Testprogram CFG-DSB0262	P000278554	02	12.06.2014	D	DSB	docx	22.10.2014	E-Mail	DSB	S	Technical		
289		CFG-DSB0262 Test Report af luft flow foregelse i generator	P000279558	01	10.07.2014	D	DSB	docx	22.10.2014	E-Mail	DSB	R	Technical		
290		Validerings rapport - Integrator CFG-DSB0262	P000279642	-	21.07.2014	D	DSB	docx	22.10.2014	E-Mail	DSB	R	Technical		
291		Grundlag for signifikansvurdering CFG-DSB0264	P000280971	02	20.08.2014	D	DSB	pdf	22.10.2014	E-Mail	DSB	R	Technical		
292		Kravsifikation CFG-DSB0264	P000277656	01	22.03.2014	D	DSB	docx	22.10.2014	E-Mail	DSB	R	Technical		
293		Arbejdsinstruktion Kabel til speedsensor & slavecylinder på PP CFG-DSB0285	P000280336	01	28.08.2014	D	DSB	docx	22.10.2014	E-Mail	DSB	R	Technical		
294		Kravsifikation CFG-DSB0285	P000280111	01	14.08.2014	D	DSB	docx	22.10.2014	E-Mail	DSB	R	Technical		
295		Arbejdsinstruktion CFG-DSB0243	P000273887	05	20.08.2014	D	DSB	pdf	22.10.2014	E-Mail	DSB	R	Technical		
296		First article test CFG-DSB0243	P000279426	01	27.06.2014	D	DSB	docx	22.10.2014	E-Mail	DSB	R	Technical		
297		Grundlag for Signifikansvurdering for ændringer CFG-DSB0243	P000272184	01	17.02.2014	D	DSB	pdf	22.10.2014	E-Mail	DSB	R	Technical		
298		Kravsifikation for CFG-DSB0243	P000272177	02	17.02.2014	D	DSB	docx	22.10.2014	E-Mail	DSB	R	Technical		
299		OIE07003 - Lista controlli riparazioni inverter JNC11_026 CFG-DSB0243	P000280202	A	04.11.2011	I	Astrid	pdf	22.10.2014	E-Mail	DSB	R	Technical		
300		Testrapport Varistor inverter-generator-fremmednet omskiftning CFG-DSB0243	P000276304	01	18.02.2014	D	DSB	pdf	22.10.2014	E-Mail	DSB	R	Technical		
301		valideringsrapport integrator CFG-DSB0243 Kondensator til Inverter	P000273908	-	27.06.2014	D	DSB	docx	22.10.2014	E-Mail	DSB	R	Technical		
302		Aerorquip FCS10-08 HI-PAC 3500 psi (prototype slange)	-	-	13.09.2011	E	Aerorquip	pdf	22.10.2014	E-Mail	DSB	S	Technical		
303		Fuel inlet pipe spec	-	-	13.09.2011	D	DSB	docx	22.10.2014	E-Mail	DSB	S	Technical		
304		plj CH100 1022 (Eaton slange biodiesel)	-	-	13.09.2011	E	Eaton	pdf	22.10.2014	E-Mail	DSB	S	Technical		
305		3992-E00VTS A01 "SIW 118"	FT3992-E00VTS	A01	28.07.2014	E	FT	pdf	19.11.2014	E-Mail	DSB	S	Technical		
306		FT3992-E01VTS A00 "Dead Train"	FT3992-E01VTS	A00	30.09.2014	E	FT	pdf	22.10.2014	E-Mail	DSB	S	Technical		
307		Test5-3 BCU_MG5634 "WSP"			August 14	E	FT	pdf	22.10.2014	E-Mail	DSB	R	Technical		
308		Test7-1 BCU_MG5634 "WSP"			August 14	E	FT	pdf	22.10.2014	E-Mail	DSB	R	Technical		
309		Test7-2 BCU_MG5634 "WSP"			August 14	E	FT	pdf	22.10.2014	E-Mail	DSB	R	Technical		
310		Test8-1 BCU_MG5634 "WSP"			August 14	E	FT	pdf	22.10.2014	E-Mail	DSB	R	Technical		
311		Test9-1 BCU_MG5634 "WSP"			August 14	E	FT	pdf	22.10.2014	E-Mail	DSB	R	Technical		
312		Test10-1 BCU_MG5634 "WSP"			August 14	E	FT	pdf	22.10.2014	E-Mail	DSB	R	Technical		
313		Synoptic Table "Service Brake DSAT18"					DSB	xlsx	22.10.2014	E-Mail	DSB	R	Technical		
314		10mar01_M1 "Service Brake DSAT18"	10mar01_M1				DSB	xlsx	22.10.2014	E-Mail	DSB	R	Technical		
315		10mar07_M1 "Service Brake DSAT18"	10mar07_M1				DSB	xlsx	22.10.2014	E-Mail	DSB	R	Technical		
316		10mar11_M1 "Service Brake DSAT18"	10mar11_M1				DSB	xlsx	22.10.2014	E-Mail	DSB	R	Technical		
317		11mar01 "Service Brake DSAT18"	11mar01				DSB	xlsx	22.10.2014	E-Mail	DSB	R	Technical		
318		11mar02 "Service Brake DSAT18"	11mar02				DSB	xlsx	22.10.2014	E-Mail	DSB	R	Technical		
319		11mar03 "Service Brake DSAT18"	11mar03				DSB	xlsx	22.10.2014	E-Mail	DSB	R	Technical		
320		IC4 Design DRIFT Evalueringsrapport CFG_DSB0246			08.10.2014	D	DSB	docx	21.10.2014	E-Mail	DSB	R	Technical		
321		RIT-DSB Driftopfølgning af CFG-DSB0103 (COS PHI)	P000273462		01.11.2013	D	DSB	docx	21.10.2014	E-Mail	DSB	R	Technical		
322		RIT-DSB Driftopfølgning af CFG-DSB0210 - IDU INI II	P000276880		01.11.2013	D	DSB	docx	21.10.2014	E-Mail	DSB	R	Technical		
323		RIT-DSB Driftopfølgning af RIT-DSB0022 - DMA, DSD Iodpedal ustabilitet	P000274965		01.11.2013	D	DSB	docx	21.10.2014	E-Mail	DSB	R	Technical		
324		RIT-DSB Driftopfølgning af RIT-DSB0003 Udvendige Døre og Trim	P000277395		01.04.2014	D	DSB	docx	21.10.2014	E-Mail	DSB	R	Technical		
325		RIT-DSB Driftopfølgning af CFG-DSB0126 (Termistor)	P000273413		01.11.2013	D	DSB	docx	21.10.2014	E-Mail	DSB	R	Technical		
326		RIT-DSB Opfølgning af RIT-DSB0002 CFG-DSB0209 (version 2)	P000279594	2	01.11.2013	D	DSB	docx	21.10.2014	E-Mail	DSB	R	Technical		
327		Description of crankshaft thrust bearing		2	22.10.2014	D	DSB	pdf	21.10.2014	E-Mail	DSB	R	Technical		
328		Progress Report Phase 1 Tasks performed, Approach planned tasks phase 2	04-03-00869	1.00	25.09.2014	E	PROSE	pdf				R	Information	04-03-00869-1.00	
329		CFG-DSB0113, Reco antenneflytning	P000216656		04.12.2013	D	DSB	pdf	27.10.2014	E-Mail	DSB	S	Technical		
330		CFG-DSB0161 El kasse, kabler	P000231287		04.12.2013	D	DSB	pdf	27.10.2014	E-Mail	DSB	S	Technical		
331		CFG-DSB0165 Ændring af tryk niveau på pressostat	P000232148		20.01.2012	D	DSB	pdf	27.10.2014	E-Mail	DSB	S	Technical		
332		CFG-DSB0167 CFG - front gaiter	P000232446		02.12.2013	D	DSB	pdf	27.10.2014	E-Mail	DSB	S	Technical		
333		CFG-DSB0168 CFG - TC håndtering front gaiter	P000232447		31.01.2012	D	DSB	pdf	27.10.2014	E-Mail	DSB	S	Technical		
334		CFG-DSB0169 CFG - elkasser samtidigt	P000233353		29.02.2012	D	DSB	pdf	27.10.2014	E-Mail	DSB	S	Technical		
335		IC4-IC2 Coupler Protection Gaiter - Silicone Laminated Gaiter Design			14.03.2013	E	Dellner	pdf	08.10.2014	E-Mail	DSB	S	Technical		
336		DSB IC4ExpA: Coupler tests			05.11.2014	E	DSB	pdf	05.11.2014	E-Mail	DSB	R	Technical		
337		Referat DellnerDSB 14052013			15.05.2014	E	DSB	pdf	27.10.2014	E-Mail	DSB	M	Information		
338		Start of delivery for coupler documentation			20.10.2014	E	DSB	mail	20.10.2014	E-Mail	DSB	M	Information		
339		141027PresentationPROSE financial figures			27.10.2014	E	DSB	pbpx	27.10.2014	E-Mail	DSB	P	Information	Financial Figures from Christian Rubenstein	
340		List of axle box support and damper events			27.10.2014	E	DSB	xlsx	27.10.2014	E-Mail	DSB	M	Technical		
341		Background story configuration & MDBF goals, Development; Baseline improvements MDBF			31.10.2014	E	DSB	pbpx	07.11.2014	E-Mail	DSB	P	Information	Søren Juhl	
342		NSA Trafikstyrelsens Answers to PROSE questions_E-Mail-06.11.2014			06.11.2014	E	NSA	mail	06.11.2014	E-Mail	DSB	M	Approval		

Project-ID : 14.104.00 Latest registered date of receipt: 02.12.2014  
 Project: Expert Assessment of IC4/2

PROSE PROJECT internal document number	Obsolete	Document Name	Document ID Issuer	Revision	Date	Language	Issuer	Format	Date receipt	receipt by	Source receipt	Type	Category	PROSE Document ID	Content
343		Technical Guide Rating Book		2	19.01.2011	E	Mecc Alte	pdf	-	-	-	S	Technical		
344		DSB presentation to Prose week 44			28.10.2014	E	DSB	ppt	30.10.2014	E-Mail	DSB	p	Organisational		
345		Centraflex fitting instruction	CF-A-14	-	-	E/D	CENTA	pdf	10.11.2014	E-Mail	DSB	S	Technical		
346		Centraflex technical description	cf-a-e-15-07_01	-	-	E	CENTA	pdf	10.11.2014	E-Mail	DSB	S	Technical		
347		Aerostyle Pyro jacket	-	-	-	E	Interlink	pdf	10.11.2014	E-Mail	DSB	S	Technical		
348		APP6-0 Vehicle engineering	APP6-0			E	DSB	pdf	24.10.2014	E-Mail	DSB	S	Technical		Part 0 of technical system requirements
349		Homologation 77 DSB litra MG i konfiguration MPTO2 med TC2.1	DKG120140018		03.11.2014	D	Trafikstyrelsen	pdf	11.11.2014	E-Mail	DSB	R	Approval		
350		SV: Common 13K100, CFGs coupler, CFG coupler safety approval				E	DSB	mail	27.10.2014	E-Mail	DSB	M	Approval		
351		Re Dokumentation til Magnetiseringskort				E	DSB	mail	12.11.2014	E-Mail	DSB	T	Information		
352		Pilot bar mounting	AA01PVR	3	08.03.2005	E	AB	pdf	07.11.2014	E-Mail	DSB	D	Technical		
353		DSB IC4ExpA Axlebox - maintenance instruction intervals				E	DSB	mail	07.11.2014	E-Mail	DSB	M	Maintenance		
354		TCMS presentation to Prose week 44			30.10.2014	E	DSB	ppt	30.10.2014	E-Mail	DSB	P	Technical		
355		Godkendelse af rullende materiel / Approval of rolling stock	10-5	8	19.05.2014	D	DSB	pdf	29.10.2014	E-Mail	DSB	R	Organisational		
356		Processbeskrivelse for risikoanalyser i DSB / Process of risk assessment in DSB Safety Management System	PR0 12-1	10	25.05.2012	D	DSB	pdf	29.10.2014	E-Mail	DSB	R	Organisational		
357		Audit P10 procedure			12.09.2013	D	DSB	docx	29.10.2014	E-Mail	DSB	R	Organisational		
358		Grundlag for Signifikansvurdering for BCU opdatering SW 1 CFG-DSB0274 'BCU Blending filosofi'	P000278414	00	05.06.2014	D	DSB	pdf	10.11.2014	E-Mail	DSB	R	Technical		
359		Signifikansvurdering for ændringer CFG-DSB0274 'BCU Blending filosofi'	1994	01	06.06.2014	D	DSB	pdf	10.11.2014	E-Mail	DSB	R	Technical		by DSB Safety (DSB Sikkerhed)
360		Captia Erklæring vedrørende CFG DSB0178 og 274 (P000282076) CFG-DSB0274 'BCU Blending filosofi'	2525337		09.07.2014	D	NSA	pdf	10.11.2014	E-Mail	DSB	R	Technical		Answer letter of NSA to "Evaluation of significance" to ID 359
361		Grundlag for signifikansvurdering CFG-DSB0290 'BCU SW, DTM, Multipel Drift'	P000281999	05	10.11.2014	D	DSB	pdf	10.11.2014	E-Mail	DSB	R	Technical		
362		BCU SW ver 116 Hjælpe skema CFG-DSB0290 'BCU SW, DTM, Multipel Drift'	P000282000		03.11.2014	D	DSB	pdf	10.11.2014	E-Mail	DSB	R	Technical		
363		Organisationsdiagram				D	DSB	ppbx	11.11.2014	E-Mail	DSB	P	Organisational		
364		DSB Sikkerhed - organisation			01.11.2014	D	DSB	ppbx	11.11.2014	E-Mail	DSB	P	Organisational		
365		Assessment report Multiple 3 and TCMS pack 2.1	211173 R1	02	17.09.2014	E	Lloyds	pdf	11.11.2014	E-Mail	DSB	R	Organisational		
366		IC2/IC4 DSB Transfer team presentation				E	DSB	ppt	11.11.2014	E-Mail	DSB	P	Organisational		
367		TCMS steps mood k15 20141104		4	03.10.2014	D	DSB	ppt	10.11.2014	E-Mail	DSB	P	Organisational		
368		DSB IC4ExpA: Status TCMS 2.1, Multiple 4			10.11.2014	E	DSB	mail	10.11.2014	E-Mail	DSB	M	Organisational		
369		DSB IC4ExpA Implementation status coupler package				E	DSB	mail	14.11.2014	E-Mail	DSB	T	Organisational		
370		APP6-01 Carbody	APP6-01			E	DSB	pdf	24.10.2014	E-Mail	DSB	S	Technical		Part 1 of technical system requirements
371		APP6-02 Bogies and Running Gear	APP6-02			E	DSB	pdf	24.10.2014	E-Mail	DSB	S	Technical		Part 2 of technical system requirements
372		APP6-04 Propulsion	APP6-04			E	DSB	pdf	24.10.2014	E-Mail	DSB	S	Technical		Part 4 of technical system requirements
373		Power Supply Alternator			13.11.2014	E	DSB	pdf	14.11.2014	E-Mail	DSB	D	Technical		
374		Km IC4 jan-okt			31.10.2014	D	DSB	xlsx	19.11.2014	E-Mail	DSB	M	Information		
375		F7-ENGINE THERMAL BALANCE (DFAT 14) - PAR. 5.1.1		3	23.11.2004	E	AB	pdf	14.11.2014	E-Mail	DSB	R	Technical		
376		DSAT 08 AA02JDJ - Medium Voltage supply	AA02JDJ	8	12.11.2014	E	DSB	.doc	24.10.2008	E-Mail	DSB	S	Technical		
377		TCMS IC4: time delay between finalized DSB validation report and approval of SW package 2.1 by Trafikstyrelsen				E	DSB	pdf	17.11.2014	E-Mail	DSB	M	Information		
378		VS CFG0264				E	DSB	pdf	20.11.2014	E-Mail	DSB	M	Information		
379		Lækage i brændstoffangsrør			01.04.2011	D	DSB	docx	13.11.2014	E-Mail	DSB	S	Technical		
380		Peak DC.DC converter Specifikationer			01.11.2008	E	Peak Electronic	pdf	12.11.2014	E-Mail	DSB	S	Technical		
381		Pictures broken bearings of motor				E	DSB	paper	10.10.2014	Hand	DSB	R	Technical		
382		IC4 - On Train Test Plan Week 41, 42 and 43, 2014		A00	11.09.2014	E	DSB	paper	02.10.2014	Hand	DSB	R	Technical		
383		Dokumentation til Magnetiseringskort			03.10.2012	D	DSB	mail	12.11.2014	E-Mail	DSB	M	Technical		
384		SV PDE.305.00 - DSBIC4 ExpA - Power Pack - further questions			11.11.2014	E	DSB	mail	11.11.2014	E-Mail	DSB	M	Technical		
385		SV PDE.305.00 - DSBIC4 ExpA - Power Pack - further questions			13.11.2014	E	DSB	mail	13.11.2014	E-Mail	DSB	M	Technical		
386		SV PDE.305.00 DSB IC4 - PowerPack (question 4)			24.10.2014	E	DSB	mail	24.10.2014	E-Mail	DSB	M	Technical		
387		SV PDE.305.00 DSB IC4 - PowerPack			23.10.2014	E	DSB	mail	23.10.2014	E-Mail	DSB	M	Technical		
388		TestB-1 BCU M1C				E	DSB	mail	17.11.2014	E-Mail	DSB	M	Technical		
389		UIC 544-1 Testre DSAT 18_DSAT 19				E	DSB	mail	14.11.2014	E-Mail	DSB	R	Technical		
390		VS PDE.305.00 DSB IC4 - Comments UIC 544-1 Testre			14.11.2014	D	DSB	mail	14.11.2014	E-Mail	DSB	R	Technical		
391		VS PDE.305.00 DSB IC4 - Comments SynopticTable Service Brake DSAT18			23.10.2014	E	DSB	mail	23.10.2014	E-Mail	DSB	R	Technical		
392		VS PROSE til CFG0230				E	DSB	mail	11.11.2014	E-Mail	DSB	M	Technical		
393		456630-E00VTR WSP dynamic test report			19.09.2013	E	FT	paper	02.10.2014	Hand	DSB	R	Technical		
394		WSP test specification	P000280214	02	10.03.2014	E	DSB	paper	02.10.2014	Hand	DSB	S	Technical		
395		F7-ENGINE THERMAL BALANCE (DFAT 14) - PAR. 5.1.1		3	23.11.2004	E	AB	pdf	14.11.2014	E-Mail	DSB	R	Technical		
396		DSAT 08 rev 8 AA02JDJ	AA02JDJ	8	24.10.2008	E	DSB	docx	12.11.2014	E-Mail	DSB	S	Technical		
397		DSAT08 final report		6		E	DSB	xlsx	12.11.2014	E-Mail	DSB	R	Technical		
398		IC4-2 EXPA Q-Issue PP-Olipipe			20.11.2014	E	DSB	docx	21.11.2014	E-Mail	DSB	R	Technical		
399		SV IC4ExpA Balance Info			20.11.2014	E	DSB	mail	20.11.2014	E-Mail	DSB	M	Organisational		correction of ID 078
400		SV IC4ExpA Balance Info hourly rate			21.11.2014	E	DSB	mail	21.11.2014	E-Mail	DSB	M	Organisational		supplementation to ID 113
401		401_3992-E00VTR_A01		A01	29.10.2014	E	FT	pdf	19.11.2014	E-Mail	DSB	R	Technical		
402		IC4-2 EXPA Q-Issue PP-Olipipe			21.11.2014	E	DSB	docx	21.11.2014	E-Mail	DSB	R	Technical		
403		Systemcertificering - Rapport	113-22559		26.06.2014	D	Force Certification	pdf	24.10.2014	E-Mail	DSB	R	Organisational		Auditreport of the ISO9001:2008-Audit
404		Fact finding mission TCMS	ECH-125.18-007	3.0	02.12.2014	E	ENOTRAC	pdf	2.12.2014	E-Mail	ENOTRAC	T	Technical	04-03-01007-000	
405		Risk estimation - IC4 Fuelpipe Engine/Powerpack		0.1	27.11.2014	E	DSB	docx	28.11.2014	E-Mail	DSB	R	Technical		
406		DistancePerMonth PEH2805			01.12.2014	D	DSB	pdf	01.12.2014	E-Mail	DSB	T	Reliability		